



	PAGE
CHAPTER 1	
SPECIFICATIONS	
1.0 General	2
1.1 Transmitter	2
1.2 Receiver	2
CHAPTER 2	
INTRODUCTION	
2.0 Introduction	3
2.1 Features	3
CHAPTER 3	
OPERATION	
3.0 Introduction	4
3.1 Control & Connections	4
3.2 Microphone	9
3.3 Operation	9
CHAPTER 4	
PROGRAMMING	
4.0 Introduction	12
4.1 Frequency Selection	12
4.2 Frequency Scanning	12
4.3 Offset Frequency Operation	14
CHAPTER 5	
CIRCUIT DESCRIPTION	
5.0 Introduction	15
5.1 PLL Circuit	15
5.2 Receiver Circuit	15
5.3 Transmitter Modulation Circuit	15
5.4 Transmitter Amplifier Circuit	15
CHAPTER 6	
ALIGNMENT	
6.0 Required Test Equipment	20
6.1 Alignment Procedures	20
CHAPTER 7	
MAINTENANCE	
7.0 Precautions	24
7.1 Periodic Inspection	24
7.2 Fuse Replacement	24
CHAPTER 8	
DIAGRAMS AND PART LIST	
8.0 PCB Layout & Part List	25

1.0 GENERAL

Model	RCI-2985DX / RCI-2995DX
Frequency Range	12 meter : 24.8900 ~ 24.9900 MHz 10 meter : 28.0000 ~ 29.6990 MHz
Tuning Steps	100 Hz, 1 KHz, 10 KHz, 100 KHz, 1 MHz
Emission Modes	AM(A3) / FM(F3) / LSB, USB(A3J) / CW(A1)
Frequency Control	Dual Phase-Lock-Loop (PLL) synthesizer
Frequency Tolerance	± 0.005%
Frequency Stability	± 0.001%
Operating Temperature Range	-10°C to +50°C
Microphone	Plug-in (6 pin), Dynamic PTT
Meter Function	Meter #1 : Indicates relative RF Power Output / Antenna SWR Meter #2 : Indicates Received Signal Strength / AM Modulation Level
Input Voltage	110V 60Hz (220V 50Hz Optional)
Antenna Connector	UHF, SO-239

1.1 TRANSMITTER

RF Power Output : RCI-2985DX : RCI-2995DX	CW/AM/FM : 10W RMS ; USB/LSB : 25W PEP CW/AM/FM : 50W RMS ; USB/LSB : 150W PEP
SSB Generation	Dual-Balanced Modulation
AM Modulation	High and Low level Class B, Amplitude Modulation
FM Deviation	± 4 KHz @ 1 KHz 30mV Audio (± 5 KHz max.)
Clarifier Range	± 5 KHz
Harmonic and Spurious Emissions	> 60dB
AM/FM Frequency Response	400 to 5000 Hz
SSB Frequency Response	400 to 3000 Hz
Output Impedance	50 Ohms
Output Indicators	RF Meter shows relative RF Output Power

1.2 RECEIVER

Sensitivity	AM/CW : < 0.50μV For 10dB S+N/N FM : < 0.25μV For 12dB S+N/N USB/LSB : < 0.15μV For 10dB S+N/N
AM/FM Selectivity	50dB at 10 KHz
SSB Selectivity	60dB at 4 KHz
Image Rejection Ratio	> 50dB
IF Rejection	> 80dB
Automatic Gain Control (AGC) Figure Of Merit	SSB/CW/AM : 80dB for 50mV for 10dB Change in Audio Output
Squelch	Adjustable-Threshold less than 0.7μV
Audio Frequency Response	400 to 2500 Hz
Distortion	< 10% at 2 Watts Output
Adjacent Channel Rejection	>50dB
Cross Modulation	>50dB
Intermediate Frequency	10.695 MHz (AM-1st, SSB), 445 KHz (AM-2nd)
Clarifier Range	± 5 KHz
Noise Blanker	IF Signal Gate Type
Audio Output Power	3W @ 10% THD
Built-in Speaker	8 Ohms, 4 Watts
External Speaker (Optional)	8 Ohms, 4 Watts

(SPECIFICATIONS SUBJECT TO CHANGE WITHOUT NOTICE)

2.0 INTRODUCTION

The Ranger RCI-2985DX / RCI-2995DX is a solid-state, fully synthesized Amateur 10 and 12 meter dual band base station transceiver with full band coverage from 28.0000 MHz to 29.6999 MHz and 24.8900 MHz to 24.9900 MHz and all mode operation, including: AM, FM, USB, LSB, CW and PA modes. The 10 most commonly used frequencies can be pre-programmed by the user for easy channel access.

2.1 FEATURES

RCI-2985DX

- 25 Watts PEP of Output Power
- Full Band Coverage
- All Mode Operation
- Brightness Control
- CTCSS Encoder/Decoder (Optional)
- Repeater/Offset Switch
- Programmable Frequencies
- Built-in Dual VFO
- RIT (RX Incremental Tuning)
- Squelch
- Noise Blanker
- RF Gain Control
- RF Power Output Selector
- External Speaker Connection
- PA Mode
- LCD Display
- Multi-Function LCD Meter

RCI-2995DX

- 150 Watts PEP of Output Power
- Full Band Coverage
- All Mode Operation
- Brightness Control
- CTCSS Encoder/Decoder (Optional)
- Repeater/Offset Switch
- Programmable Frequencies
- Built-in Dual VFO
- RIT (RX Incremental Tuning)
- Squelch
- Noise Blanker
- RF Gain Control
- RF Power Output Selector
- External Speaker Connection
- PA Mode
- LCD Display
- Multi-Function LCD Meter

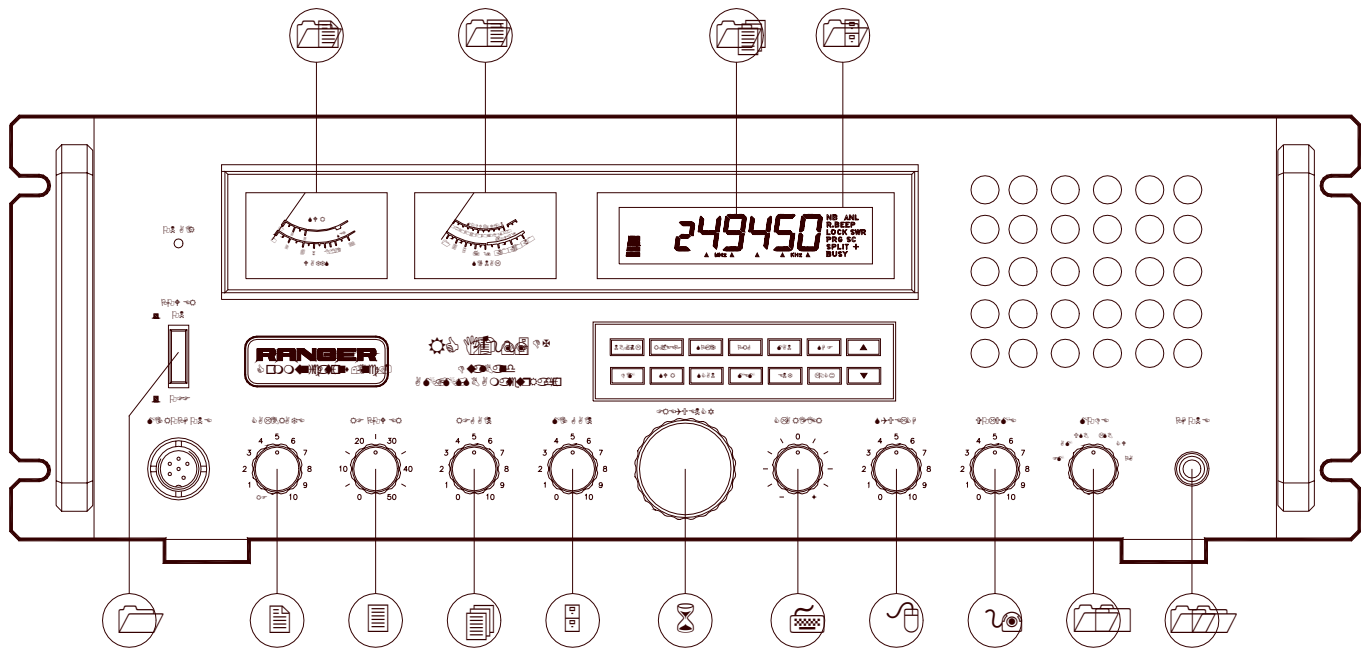

Figure 3-1 Front Panel

3.0 INTRODUCTION

This section explains the basic operating procedures for the RCI-2985DX / RCI-2995DX Amateur 10 and 12 meter dual band base station transceiver.

3.1 CONTROL AND CONNECTIONS

3.1.1 FRONT PANEL

Refer to the above Figure 3-1 for the location of the following controls.

1. POWER ON/OFF SWITCH

Push this switch to apply power to the unit.

2. CALIBRATE CONTROL

This control is used for calibrating the built in SWR meter for accurate SWR readout. Control should normally be left in the fully counter clockwise position for accurate power output meter readings. (This stop is marked “RF”)

3. RF POWER CONTROL

This control allows the user to adjust RF power output.

4. RF GAIN CONTROL

This control is used to reduce the gain of the RF amplifier under strong signal conditions.

5. MIC GAIN CONTROL

Adjusts the microphone gain in the transmit and PA mode. This controls the gain to the extent that full talk power is available several inches away from the microphone. In the Public Address (PA) mode, the control functions as the volume control.

6. CHANNEL SELECTOR

This control is used to select a desired transmit and receive channel.

7. CLARIFIER CONTROL

Allows adjustment of the receive frequency above or below the channel frequency. Although this control is intended primarily to tune in SSB signals, it may be used to optimize AM/FM signals as well.

8. SQUELCH CONTROL

This switch is used to eliminate background noise being heard through the receiver which can be disturbing when no signal is being received. To use this feature of your radio, gently turn the switch fully counterclockwise, and then turn clockwise until the background noise is just eliminated. Further clockwise rotation will increase the threshold level so that only strong signals will be heard.

9. VOLUME CONTROL

Turn clockwise to set the desired listening level.

10. MODE SELECTOR

This selector allows you to select one of the following operating modes: FM/AM/USB/LSB/CW/PA.

11. PHONE JACK

Accepts a plug from a headset of 4 to 32 Ohm impedance. Insertion of the plug will disable the built-in speaker and external speaker connected to External Speaker jack.

12. RF/SWR METER

Used for two purpose - to indicate approximate transmitter power when transmitting and antenna SWR (standing wave ratio). Note that the power meter has separate scales for AM, FM, SSB and CW transmission, respectively.

13. SIGNAL/MODULATION METER

This meter indicates signal strength when receiving and modulation percentage when transmitting in the AM mode. Modulation readings are most accurate when using maximum output power. The modulation meter does not show movement in FM or SSB, but the Power Output meter (RF/SWR) does indicate RF out in these modes.

14. FREQUENCY DISPLAY

The frequency display indicates the frequency of the selected channel you wish to operate on.

15. FUNCTION INDICATORS

The indicators permit you to know instantly the mode to which the unit is engaged.

3.1.2 PROGRAMMING KEY PAD

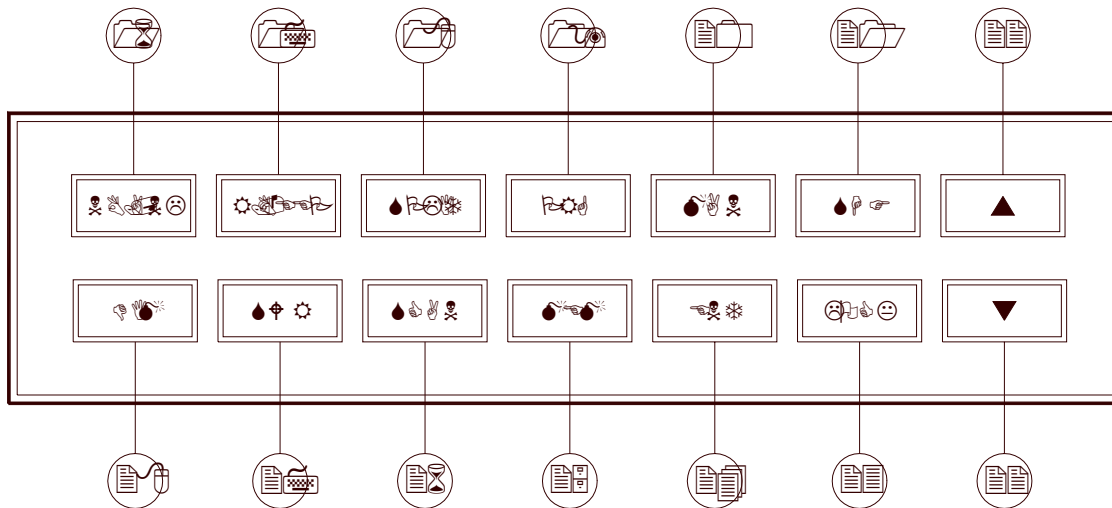

16. NB/ANL/OFF SWITCH

In the NB/ANL position, the RF Noise Blanker and the Automatic Noise Limiter in the audio circuits are also activated. The Noise Blanker is very effective in eliminating repetitive impulse noise such as ignition interference.

17. ROGER BEEP BUTTON (R.BEEP)

In the Roger Beep position, the radio transmits an audio tone at the end of your transmission to indicate that transmission has ended. As a courtesy to others, use the Roger Beep only when necessary.

18. SPLIT BUTTON (SPLIT)

This control activates the offset frequency function. It causes the transmit frequency to be offset either above or below the receive frequency by a user programmable amount to allow operation of a FM Repeater.

19. PROGRAM BUTTON (PRG)

This button is used to program operating or scanning frequencies into memory. See the OPERATION section of the manual for further details.

20. MANUAL BUTTON (MAN)

This is used to return the unit to manual mode.

21. SHIFT BUTTON (SHF)

This is used to select 100 Hz, 1 KHz, 100 KHz or 1MHz frequency steps.

22. UP/DOWN SELECTOR (▲▼)

These buttons are used in conjunction with the shift key to move the frequency upward or downward to select a desired frequency.

23. LOCK BUTTON (LOCK)

This button is used to lock a selected frequency. Press it to activate the switch. In this position, it disables the Frequency Selector Control, up/down buttons on the front control panel and remote up/down buttons on the microphone. Repressing the switch will unlock the frequency.

24. ENTER BUTTON (ENT)

This is used to program memory channels. See the OPERATION section of this manual for more information on using this control.

25. MEMORY BUTTON (MEM)

This button is used to program memory channels. Detailed information on how to use this control is provided in the OPERATION section of this manual.

26. SCAN BUTTON (SCAN)

This is used to scan frequencies in each band segment. The OPERATION segment of this manual provides detailed information on using the SCAN control.

27. SWR BUTTON (SWR)

This button is used to check SWR.

28. DIM BUTTON (DIM)

This button adjusts the display backlighting in four different steps to best match the ambient light.

3.1.3 REAR PANEL

Figure 3-2 represents the location of the following connections:

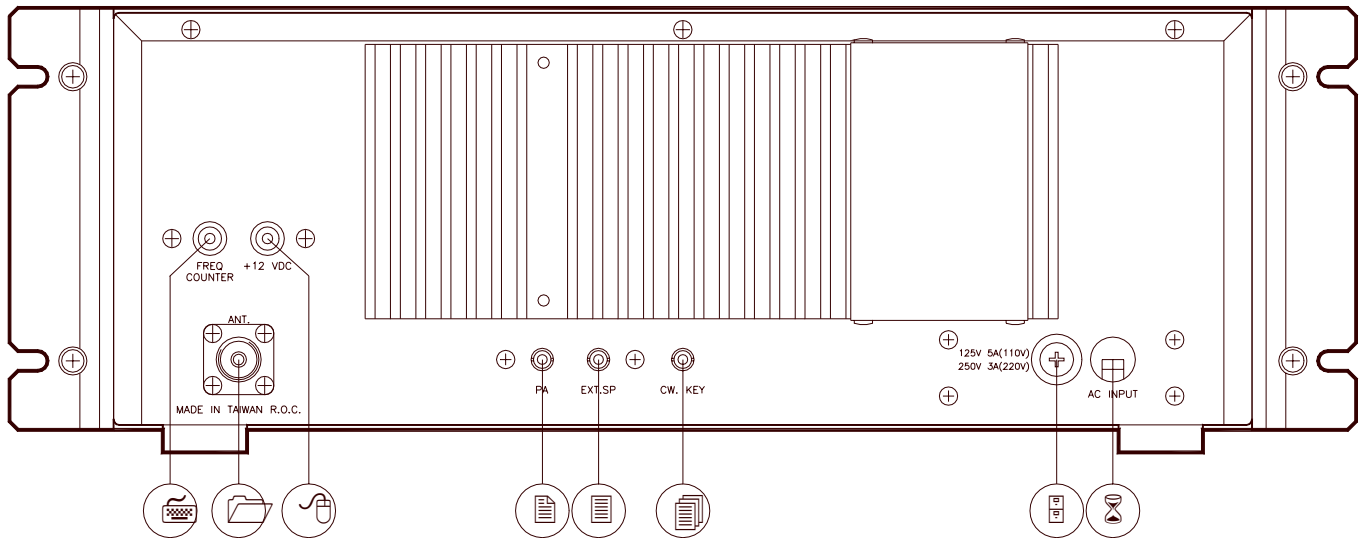

Figure 3-2 Rear Panel

1. ANTENNA

This jack accepts 50 ohms coaxial cable with a PL-259 type connector.

2. PA. SPEAKER

This jack is for PA operation. Before operating, you must first connect a PA speaker (8 ohms, 4 W) to this jack.

3. EXT. SP.

This jack accepts a 4 to 8 ohm, 4 watt external speaker. When the external speaker is connected to this jack, the built-in speaker will be disabled.

4. CW KEY

Used for Morse code operation. Connect a CW key to this jack and set the **MODE SELECTOR** switch to the CW position.

5. FUSE

Accommodates a fuse for AC input circuit protection. Use a 125V 5A fuse for replacement.

6. AC POWER CORD

Connect to AC power outlet for AC mains supply.

7. FREQUENCY COUNTER OUTPUT JACK

This “RCA Phono” type jack provides output for connecting an optional frequency counter so that you can watch the transmit frequency on an external frequency counter.

8. +12 VDC

This “RCA Phono” type jack provides 12 VDC power for an optional external cooling fan.

3.2 MICROPHONE

1. PTT SWITCH

The receiver and transmitter are controlled by the push-to-talk switch on the microphone. Press the switch and the transmitter is activated, release the switch to receive. When transmitting, hold the microphone two inches from your mouth and speak clearly in a normal voice. The transceiver comes complete with a low impedance (500 ohm) dynamic microphone.

2. REMOTE UP/DOWN SWITCH

An operating frequency can be increased or decreased simply by pushing either of these buttons.

3.3 OPERATION

3.3.1 CHANNEL SELECTION

Frequency selection for the RCI-2985DX / RCI-2995DX is simple. Select a desired operating frequency by rotating the Frequency Selector, or using the (▲) Up and (▼) Down buttons on the front panel or the microphone. Press the LOCK button to lock into the selected frequency. This will disable the Frequency Selector and the up/down buttons on the front panel and the microphone. Repeating the LOCK button unlocks the frequency. Use the SHF button to step frequency in 100 Hz, 1 KHz, 10 KHz, 100 KHz or 1 MHz increment when you select a band segment. The frequency step is indicated by a small triangle directly under the corresponding digit on the frequency display.

3.3.2 MODE SELECTION

To select an operating mode on your RCI-2985DX / RCI-2995DX, simply rotate the MODE selector and place it in the desired operating mode position FM/AM/USB or LSB modes are for your voice communications. In the CW position, you can transmit CW if you have connected an external key to the accessory jack provided on the back of the radio. In the PA position, the transceiver can be used as a Public Address system. Before operating in PA mode, you must first connect a PA speaker (8 ohms, 4 Watt) to the jack located on the rear panel.

3.3.3 RF POWER CONTROL

This feature allows the adjustment of the RF output power continuously over the range of 1W through 25W (RCI-2995DX : 2W through 150W).

3.3.4 RECEIVE SCANNING

Receive scanning allows you to find active frequencies in the entire band segment. To begin scanning, slowly turn the Squelch control clockwise until the receiver noise disappears. Press the Scan button. The unit should start scanning from the lower to the higher frequencies. Pressing the Scan button again will change the direction of scanning. Each time you press the Scan button, "SCAN+" or "SCAN-" will be displayed on the LCD display. The radio will stop on any active frequency for the entire duration of the transmission. When the transmission stops, the RCI-2985DX / RCI-2995DX will wait approximately 2 seconds before it resumes scanning. If you want to deactivate Scan mode while it is scanning, press the MAN (manual) button or turn the Squelch control counterclockwise until you hear the receiver noise. The Manual button will disable Scan function.

3.3.5 SPLIT FUNCTION

This function enables you to offset the transmit and receive frequencies for FM repeater operation. The transmitter frequency can offset either higher or lower than the receive frequency. To split frequencies,

press the **MAN** button and the **Split** button to select either +/- split frequency. If the + split is selected, the transmit frequency will be higher than the receive frequency. If - split is selected, the transmit frequency will be lower than the receive frequency.

3.3.6 MEMORY FUNCTION

The RCI-2985DX / RCI-2995DX can store up to 10 most frequently used frequencies (from 0 to 9). To program a frequency into memory, follow the procedure described below:

- (1) Press the **MAN** button.
- (2) Press the **PRG** button.
- (3) Press the **MEM** button (“MEMORY” and “0” should appear on the left-hand side of the **LCD** display). Pressing the **MEM** button will advance the channel number from “0” to “9”.
- (4) Select the desired frequency you wish to store in memory.
- (5) Press the **ENT** button.
- (6) Repeat the same procedure to program other memory channels.

3.3.7 MEMORY CHANNEL SCANNING

You can scan and select any of these 10 preset frequencies by following the procedure described below:

- (1) Press the **MAN** button.
- (2) Press the **MEM** button.
- (3) Slowly turn the Squelch knob clockwise until the receiver noise disappears.
- (4) Press the Scan button. The unit will scan from lower to higher frequencies. When you press the button again, it will scan from higher to lower frequencies.
- (5) To stop scanning a certain channel, press the **MAN** button, or turn the Squelch knob counterclockwise until you hear the receiver noise.

3.3.8 METER

The meter built into your RCI-2985DX / RCI-2995DX on the left hand side of the **LCD** display provides the following information:

1. SIGNAL/MODULATION METER

In transmit mode, it provides a visual indication of modulation percentage when transmitting in the AM mode and received signal strength on the receive mode.

2. RF/SWR METER

This meter has two purpose. It indicates relative transmitter power when transmitting and antenna SWR (Standing Wave Ratio). In order to achieve maximum radiated power, it is important that your antenna be in good condition, properly adjusted and matched to your transceiver. The built-in SWR (Standing

Wave Ratio) meter allows you to measure your antenna condition. To operate this function, connect your antenna to the transceiver antenna connector, set the mode switch to AM and adjust the MIC Gain to minimum. Select a frequency near the middle of the band you plan to use most. Activate the SWR function and press the PTT button on the microphone. A bar on the meter is an indication of the antenna matching. If there is no bar, it indicates that your antenna system is perfectly matched. The less bar, the better matched. If several bars appear, your antenna needs adjusting. The SWR function is self calibrating.

3.3.9 CTCSS - OPTIONAL

The RCI-2985DX / RCI-2995DX can operate with CTCSS frequencies for accessing repeaters, with an optional CTCSS (Continuous Tone Coded Squelch System) encoding device installed.

3.3.10 PROCEDURE TO RECEIVE

- (1) Be sure that the power source, microphone and antenna are connected to the proper connectors before going to the next step.
- (2) Press the **POWER** switch to apply power to the transceiver.
- (3) Set the **VOL.** to a comfortable listening level.
- (4) Set the **MODE** switch to the desired mode.
- (5) Listen to the background noise from the speaker. Turn the **SQUELCH** knob slowly clockwise until the noise just disappears. The **SQUELCH** is now properly adjusted. The receiver will remain quiet until a signal is actually received. Do not advance the control too far or some of weaker signals will not be heard.
- (6) Set the **CHANNEL** selector switch to the desired channel.
- (7) Set the **RF GAIN** control fully clockwise for maximum RF gain.
- (8) Adjust the **CLARIFIER** control to clarify the SSB signals or to optimize AM/FM signals.

3.3.11 PROCEDURE TO TRANSMIT

- (1) Select the desired channel of transmission
- (2) Set the **MIC GAIN** control fully clockwise.
- (3) If the channel is clear, depress the push-to-talk switch on the microphone and speak in a normal voice.

RCI-2985DX
RCI-2995DX

CHAPTER 4
PROGRAMMING

4.0 INTRODUCTION

This section explains the basic programming procedures for the RCI-2985DX / RCI-2995DX Amateur 10 and 12 meter dual band base station transceiver.

4.1 FREQUENCY SELECTION

Frequency selection in the RCI-2985DX / RCI-2995DX can be accomplished using anyone of the three following methods:

- (1) The first method of frequency selection is through the use of the **SHF** (Shift) key and the (▲) Up and (▼) Down arrows. To accomplish this, press the **SHF** button until the cursor arrow is positioned under the digit of the frequency that is to be changed, then use the (▲) Up arrow to increase the number. If a decrease in frequency is desired, press the (▼) Down arrow. Perform the steps described above for each digit of the frequency until the desired frequency is displayed in the LCD display window.
- (2) The second method of frequency selection is accomplished using the **SHF** button and the frequency select knob located on the front panel. Use the **SHF** button in the manner described above to select the digit to be changed. Proceed to rotate the frequency select knob clockwise to increase the frequency. Rotate the frequency select knob counterclockwise to decrease the frequency.
- (3) The third method of selecting the operating frequency of the radio is through the use of the **SHF** button and the Channel (▲) Up and (▼) Down buttons located on the microphone. Frequency selection by this method is accomplished in the same manner as with the (▲) Up and (▼) Down arrows on the keypad. The only difference is that the Channel Up and Down buttons on the microphone is used.

4.2 FREQUENCY SCANNING

Frequency scanning can be achieved using one of two methods: the first method involves the scanning of pre-programmed memory channels. The second method permits the user to scan all frequencies between a pre-set upper and lower scan limit. Both of the methods of the frequency scanning.

4.2.1 ALL FREQUENCY SCANNING

To allow all Frequency Scanning, one must first program the upper and lower scanning limits. The scan limits are simply the highest and lowest frequencies that will be scanned. To program these limits, perform the following steps:

- (1) Press the **PRG** (Program) key.
- (2) Press the **SCAN** key (“**PRG SCAN+**” should appear in the lower right corner of the display window).
- (3) Using the **SHF** key and the (▲) Up and (▼) Down arrows, select the upper scan limit, then press **ENT**.
- (4) Press the **SCAN** key again (“**SCAN-**” should appear in the display window).
- (5) Using the **SHF** key and (▲) Up and (▼) Down arrows, select the lower scan limit, then press **ENT**.

The upper and lower scan limits have now been programmed. To activate the scan feature, return the radio to manual operation and press the **SCAN** button. If the display shows “**SCAN+**”, the radio will scan from the lower limit to the upper limit. If “**SCAN-**” is displayed, the unit will scan from the upper limit to the lower limit. To change from **SCAN+** to **SCAN-** or vice versa, press **SCAN**.

NOTE

When programmed, the upper and lower scan limits will also act as the upper and lower operating limits of the radio. The radio now cannot be programmed to operate above or below the scan limits.

4.2.2 MEMORY SCANNING

The RCI-2985DX / RCI-2995DX has 10 non-volatile (i.e. memory resident) memory locations which can be programmed with any available frequency within the operating band of the radio. The scan function of the unit can be programmed to scan these memory channels. The radio will then scan only those memory channels which have been programmed. The first step in utilizing the memory scan function is to program the desired frequencies into the radio memory. This can be accomplished by performing the following steps:

- (1) With the radio operating in the manual mode, press the **PRG** (Program) key.
- (2) Press the **MEM** (Memory) key. “**PRG**” should be displayed in the lower right-hand corner of the LCD display window. In the upper left portion of the display, “**MEMORY**” should be displayed. Directly below **MEMORY**, a number between 0 and 9 will be displayed. This number represents the memory location currently being displayed. Pressing the **MEM** key will increase the memory counter to the next memory location and the contents of that memory location will be displayed.
- (3) Using the **SHF** key and the (▲) Up and (▼) Down arrows, enter the frequency to be stored in the memory location displayed. After the desired frequency has been entered, press **ENT**.
- (4) Repeat steps (2) and (3) for all the memory locations to be programmed.
- (5) After all desired memory locations have been programmed with frequencies, return the unit to the manual mode of operation by pressing the **MAN** key.
- (6) To initiate memory scanning, press **MEM** and then press **SCAN**. As previously discussed, the display will show “**SCAN+**” or “**SCAN-**” to indicate whether the radio is scanning from the lowest or the highest memory location or vice versa.
- (7) To return the radio to normal (non-scanning) operation, press the **MAN** key.

4.3 OFFSET FREQUENCY OPERATION

The RCI-2985DX / RCI-2995DX has an offset or split frequency feature that will permit the radio to be operated in a half-duplex mode. This will allow the user to talk on FM repeaters operating in the 10 and 12 Meter dual band.

NOTE

The FM repeaters may require a subaudible (CTCSS) tone be transmitted to gain access to the repeater. The RCI-2985DX / RCI-2995DX is not factory equipped with a CTCSS encoder/decoder.

The split frequency function offsets the transmitter frequency either above or below the receive frequency by a user programmable amount. In the following example, programming of a 100 KHz offset will be described. Before attempting to program the offset frequency, ensure that the radio is operating in the manual mode by pressing the **MAN** key.

- (1) Press the **PRG** (Program) key.
- (2) Press the **SPLIT** key. The LCD display window will display “00000” with “PRG” and “SPLIT” being displayed in the lower left hand corner.
- (3) Using the **SHF** key and the (▲) Up and (▼) Down arrows as described earlier, program the display to read “010000”.
- (4) Press **ENT**. A 100 KHz offset has now been programmed into the radio.
- (5) Return the radio to manual operation by pressing the **MAN** key.
- (6) Using the **SHF** key and the (▲) Up and (▼) Down arrows as described previously, set the radio for the desired receive frequency.
- (7) Press **SPLIT**. In the lower right corner of the display, either “SPLIT+” or “SPLIT-” will be displayed. If **SPLIT+** is displayed, the transmitter will be offset 100 KHz above the receive frequency when keyed. If **SPLIT-** is displayed, the transmitter will be offset 100 KHz below the receive frequency.

NOTE

When the transmitter is keyed, the frequency display will change to show the frequency being transmitted.

- (8) To return the radio to simplex operation (i.e., same transmit and receive frequency), press the **MAN** key.

RCI-2985DX
RCI-2995DX

CHAPTER 5
CIRCUIT
DESCRIPTION

5.0 INTRODUCTION

This section explains the technical theory of operation for the RCI-2985DX / RCI-2995DX Amateur 10 and 12 meter dual band base station transceiver.

5.1 PLL CIRCUIT

The Phase Lock Loop (PLL) circuit is responsible for developing the receiver's first local oscillator signal and the transmitter's exciter signal. The PLL circuit consists primarily of IC2, IC3, Q29, Q32, Q33, Q34, Q36, Q37, Q38 and L16. The PLL circuit is programmed by the rotary channel switch GPS-0751. The switch allows IC (U601) on CPU PCB to communicate the correct binary data information to the programmable divider inside of IC2. IC2 then controls the VCO (Voltage Controlled Oscillator) to oscillate on the correct frequency. This signal is fed either into the receiver's first mixer (for receive operation) or the transmitter's mixer (for transmit operation).

5.2 RECEIVER CIRCUIT

The incoming RF signal comes into the radio via the antenna and into the front-end pre-amp, Q19. The RF signal is fed into the mixer circuit of Q20 and Q21. The signal is then filtered by L8, L9 and L10 then into the AM/FM IF section of the receiver (depending on the mode of operation). The signal is then detected by either the AM detector or FM detector and then fed to the audio amplifier section of the receiver and finally out to the speaker.

5.3 TRANSMITTER MODULATION CIRCUIT

- (1) The transmitter modulation circuit modulates the low-level RF signal from the PLL exciter circuit with the user's audio voice signal from the microphone. The audio from the microphone is then amplified and fed into the balanced modulator circuit.
- (2) If the transceiver is in the AM mode, the AF Power amplifier modulates the last RF amplifier, which produces a true amplitude modulated RF signal.
- (3) If the transceiver is in the FM mode, the audio signal is not mixed with 10.6975MHz oscillator but instead phase modulates the basic exciter signal from the PLL circuit in the TX mixer.
- (4) If the transceiver is in the SSB mode, the audio signal is mixed with the 10.6975MHz oscillator in IC5.

5.4 TRANSMITTER AMPLIFIER CIRCUIT

The transmitter takes the basic exciter signal from the TX mixer and amplifies it through a series of amplifiers consisting of Q64, Q63, Q62, Q61, Q60 and EPA010010B (only for RCI-2995DX) where it is then sent out to the antenna connector.

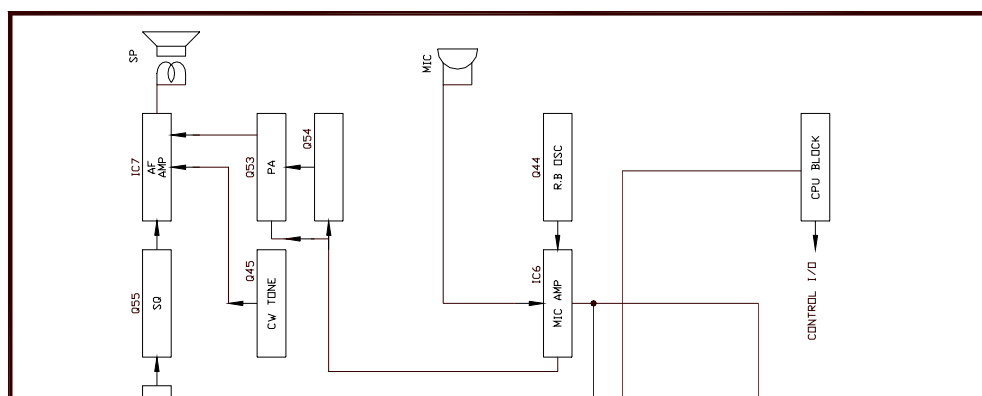

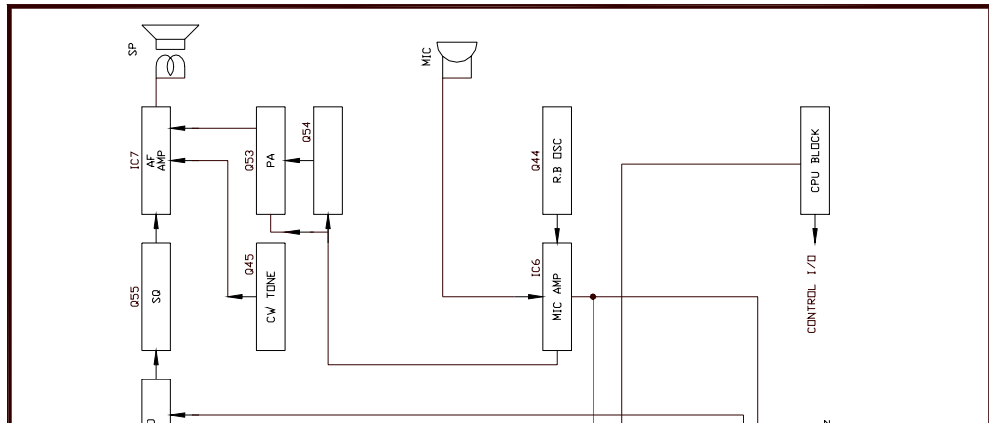

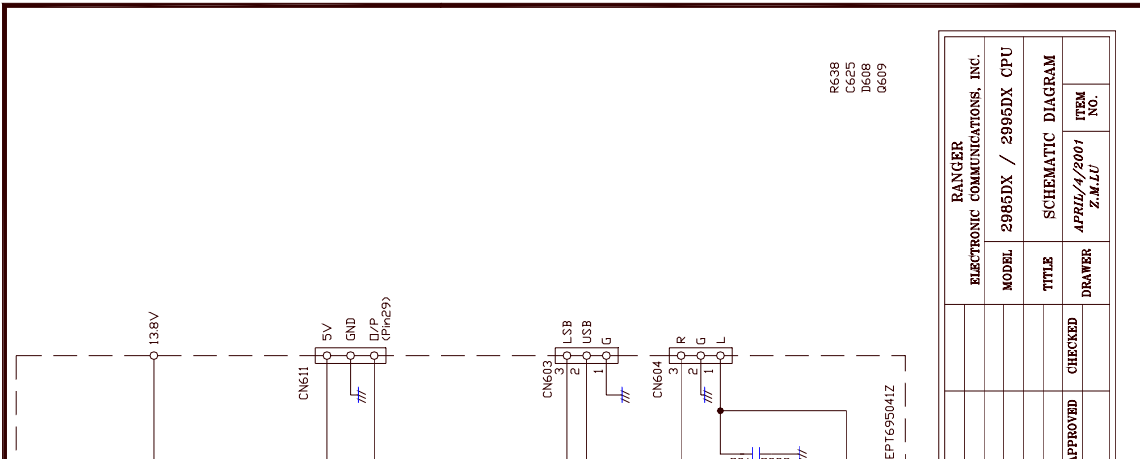

R638
C625
D608
0609

RANGER		ELECTRONIC COMMUNICATIONS, INC.	
MODEL	2985DX / 2985DX CPU	TITLE	SCHEMATIC DIAGRAM
DRAWER		CHECKED	
APPROVED		DRAWER	Z.M.LU
		ITEM NO.	

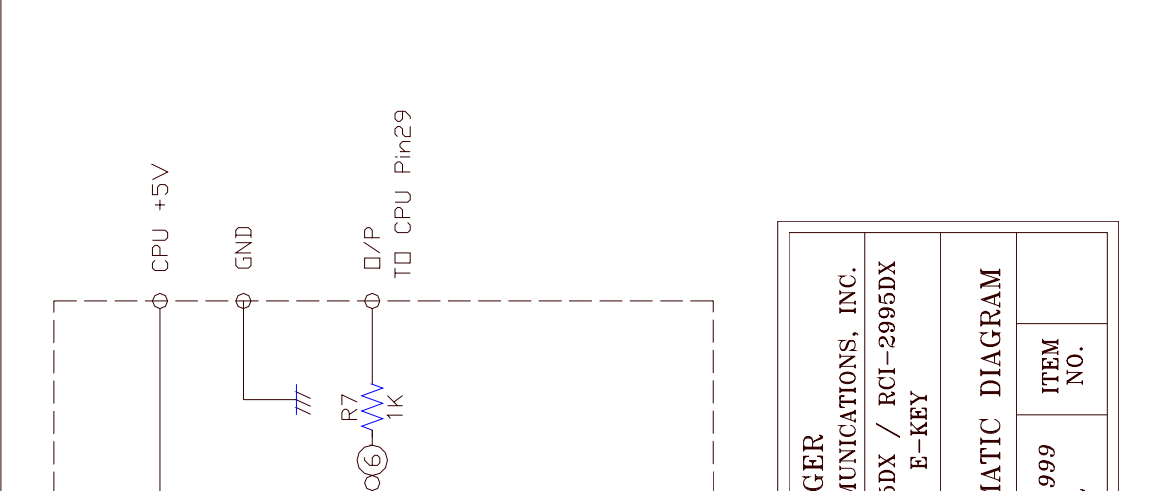

GER MUNICATIONS, INC.	
00DX / RCI-2995DX E-KEY	
SCHEMATIC DIAGRAM	
999 /	ITEM NO.

RCI-2985^{DX}
RCI-2995^{DX}

CHAPTER 6
ALIGNMENT

6.0 REQUIRED TEST EQUIPMENT

- | | |
|------------------------------|---------------------------------|
| ① AC Power Supply (110V AC) | ⑥ Frequency Counter (100 MHz) |
| ② RF Wattmeter | ⑦ RF Signal Generator (100 MHz) |
| ③ Multimeter | ⑧ Automatic Distortion Meter |
| ④ Automatic Modulation Meter | ⑨ Oscilloscope (50 MHz) |

6.1 ALIGNMENT PROCEDURES

This transceiver has been aligned at the factory and does not require any adjustments at installation. The required test equipment listed are used for the test setup or alignment shown in Figure 6-1 Transmitter Test Setup and Figure 6-2 Receiver Test Setup. These test setups are used in part or total during the following adjustments and refer to Page 59 for adjustment location.

6.1.1 PLL ALIGNMENT

ITEM	U.U.T. SETTING	ADJUST POINT	MEASUREMENT
PLL 2 VCO Voltage	Set radio to 24.890 MHz, AM RX mode. Frequency setting at 29.699 MHz. Connect Multimeter to TP10.	L14	1.0 VDC \pm 0.1 \leq 4.5 VDC
PLL 1 VCO Voltage	Set radio to 24.890 MHz, AM RX mode. Frequency setting at 29.699 MHz. Connect Multimeter to TP11.	L13	1.0 VDC \pm 0.1 \leq 6.5 VDC
AM Frequency	Set radio to AM RX mode. Set Clarifier Control to 12 o'clock. Connect Frequency Counter to TP16.	VC2	10.100 MHz \pm 10 Hz
TX Frequency	Set radio to AM TX mode. Connect Frequency Counter to TP16.	VR8	10.100 MHz \pm 10 Hz
VCO Output	Set radio to 28.000 MHz, AM RX mode. Connect Oscilloscope to TP3.	L17	Maximum Output 38.6950 MHz.
AM OSC	Set radio to AM TX mode. Mod off Connect Frequency Counter to TP5.	L18	10.6950 MHz \pm 10 Hz
USB OSC	Set radio to USB TX mode. Mod off. Connect Frequency Counter to TP5.	L20	10.6975 MHz \pm 10 Hz
LSB OSC	Set radio to LSB TX mode. Mod off. Connect Frequency Counter to TP5.	L19	10.6925 MHz \pm 10 Hz

6.1.2 TRANSMITTER ALIGNMENT

RCI-2995DX LEVELS ARE SHOWN IN [].

ITEM	U.U.T. SETTING	ADJUST POINT	MEASUREMENT
TX Power	Set radio to 28.000 MHz, AM TX mode. Modulation off. Set radio to 28.000 MHz, USB TX mode. AF signal 30mV, 1 KHz to microphone. Connect Oscilloscope to TP17. Set RF PWR Fully Clockwise. Set Clarifier Control to 12 o'clock.	L18,L37, L35,L34	Maximum Output.

	Set radio to 24.890 MHz and 29.699 MHz.	L35,L34	Maximum Output and Balance.
AM APC	Set radio to AM TX mode. Connect Multimeter to TP8.	VR15	6 VDC
SSB APC	Set radio to USB TX mode. Connect Multimeter to TP8.	VR18	12.5 VDC
BIAS Current	Set radio to USB TX mode. Modulation off. Connect current meter to TP7(+) and TP9(-). Connect current meter to TP7(+) and TP8(-).	VR13 VR12 + VR11	10 mA (50 mA + 50 mA) = 100 mA
AM TX Power	Set radio to 28.000 MHz, AM TX mode. Modulation off. Connect "short PCB" to TP7 and TP9. Set RF PWR Fully Counter Clockwise. Connect RF Power Meter to antenna jack.	VR15 VR19	10W [50W] 1W [2W]
RF Power Meter	Set radio to 28.0000 MHz, AM TX mode. Set RF Power Fully Clockwise.	VR10	Meter Indicator
SSB ALC	Set radio to USB TX mode. AF signal 30mV, 1 KHz to microphone.	VR14	25W [100W]
SSB Carrier Balance	Set radio to USB TX mode. AF signal 30mV, 1 KHz to microphone. Connect Oscilloscope to antenna jack.	VR7	Spurious Emission to minimum.
CW TX	Set radio to 28.000 MHz, CW TX mode. Plug in CW Key. Disconnect the Mic Jack. Connect AC Voltmeter to EXT SP.	VR9	200mV (Sine Wave)
AM Modulation FM Modulation	Set radio to 28.000 MHz, AM TX mode. Set radio to 28.000 MHz, FM TX mode. AF signal 30mV, 1 KHz to microphone. Set Mic Gain Fully Clockwise.	VR17	90% 4KHz

6.1.3 RECEIVER ALIGNMENT

ITEM	SETTINGS	ADJUST POINT	MEASUREMENT
AM Sensitivity	Set radio to 28.000 MHz, AM RX mode. Set Clarifier Control to 12 o'clock. Set RF Gain Fully Clockwise. Set SQ Fully Counter Clockwise. Set NB/ANL/OFF switch to OFF position. Set VOL Control at 2 o'clock. Connect RF SG to antenna jack. Frequency 28.000 MHz, 1uV. Mod 30%. Set radio to 24.890 MHz, AM RX mode.	L5,6,7,8,9,10, 2,3 L5,L6, L7	Audio Output > 2V S/N > 10 dB Balance between

	RF SG setting 24.890 MHz. Set radio to 29.699 MHz, AM RX mode. RF SG setting 29.699 MHz.		24.890 and 29.699 MHz
USB Sensitivity	Set radio to USB RX mode. VOL. Control Fully Clockwise. RF SG setting 28.001 MHz, 0.5uV. Mod off.	L11, L12	Audio Output > 2V S/N > 10 dB
LSB Sensitivity	Set radio to LSB RX mode. VOL Control Fully Clockwise. RF SG setting 27.999 MHz, 0.5uV. Mod off.	L11, L12	Audio Output > 2V S/N > 10 dB
FM Distortion	Set radio to 28.000 MHz, FM RX mode. Set MODE switch to FM mode. RF SG setting 28.000 MHz, 1mV. Mod 3KHz.	L4	Audio Output > 3V Distortion < 10%
NB Adjust	Set radio to 28.000 MHz, AM RX mode. RF SG setting 28.000 MHz, 100uV. Mod off. Set NB/ANL/OFF switch to NB/ANL position. Connect Voltmeter to TP1.	L1	DC Voltage to max. > 2V
AM Squelch	Set radio to 28.000 MHz, AM RX mode. Set SQ Control Fully Clockwise. RF SG setting 28.000 MHz, 1mV. Mod 30%.	VR4 Slowly	Adjust very slowly until squelch just open.
SSB Squelch	Set radio to USB RX mode. Set SQ Control Fully Clockwise. RF SG setting 28.001 MHz, 1mV. Mod off.	VR3 Slowly	Adjust very slowly until squelch just open.
AM S/Rf Meter AM S-Meter	Set radio to 28.000 MHz, AM RX mode. RF SG setting 28.000 MHz, 100uV. Mod 30%.	VR1	"6 bar" on the Level Meter Indicator and Meter needle to S9 on the S scale.
SSB S-Meter	Set radio to USB RX mode. RF SG setting 28.001 MHz, 100uV. Mod off.	VR2	"6 bar" on the Level Meter Indicator and Meter needle to S9 on the S scale.

Figure 6-1 Transmitter test setup

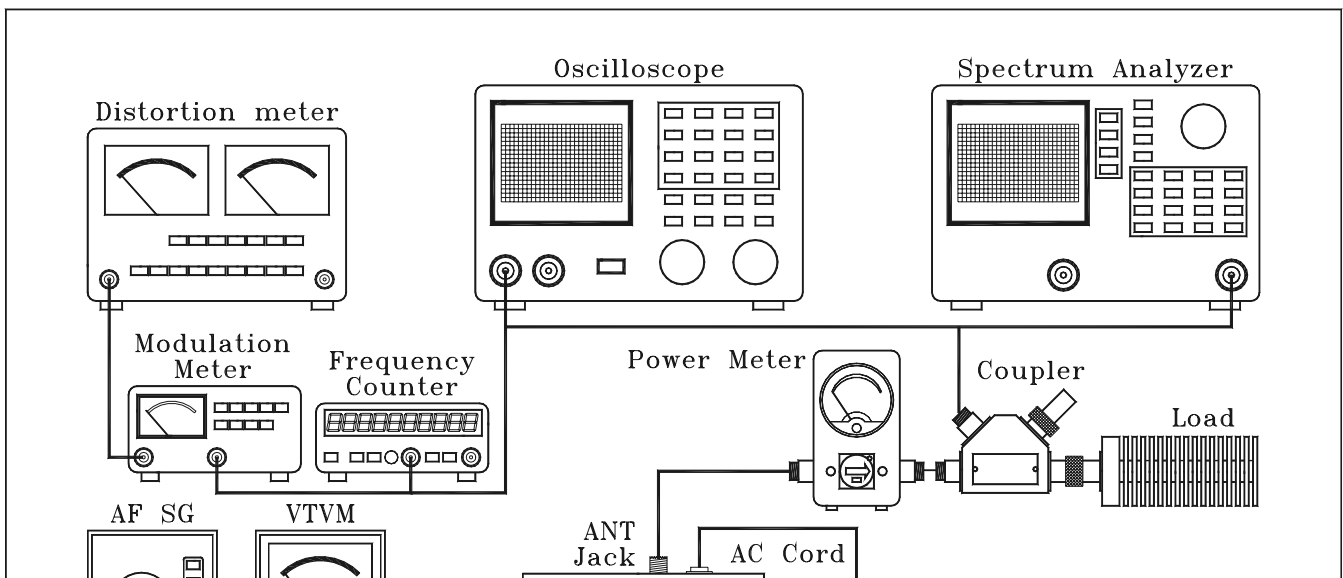

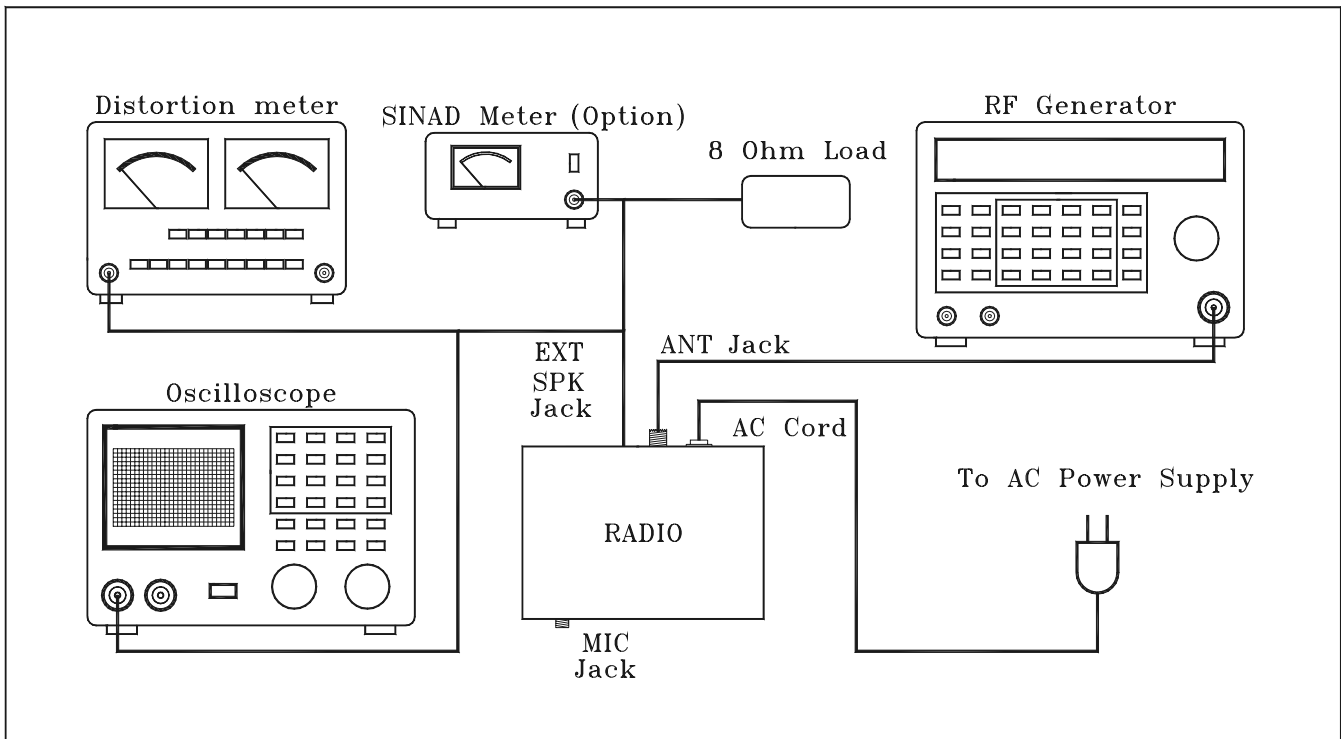

Figure 6-2 Receiver test setup

RCI-2985DX
RCI-2995DX

CHAPTER 7
MAINTENANCE

7.0 PRECAUTIONS

The inherent quality of the solid-state components used in this transceiver will provide many years of continuous use. Taking the following precautions will prevent damage to the transceiver.

- (1) Never key the transmitter unless an antenna or suitable dummy load is connected to the antenna receptacle.
- (2) Ensure that the input voltage does not exceed 110 V AC.

- (3) During alignment, do not transmit for more than 10 seconds at a time. Transmitting over long periods can cause heat built-up and cause transmitter damage.

7.1 PERIODIC INSPECTION

This unit is aligned at the factory to deliver maximum performance. However, continued performance cannot be expected without periodic inspection and maintenance. Important points to be checked regularly are as follows;

Check Item	Action
Whip antenna (option)	If cracked or broken, replace it.
Coaxial cable	If sheath is cracked, seal with vinyl tape. If immersed with water, install new coaxial cable.
Coaxial & power plug connections	If loosened, reconnect. If corroded, clean contacts.
Ground terminal	If corroded, clean terminal.

7.2 FUSE REPLACEMENT

To protect the equipment from serious damage, a fuse is provided on the power supply lines. The fuse protect against over voltage / reverse polarity or internal fault of the equipment. If the fuse has blown, first find out the cause of the trouble before replacing it. A fuse rated for more than the transceiver requirement should not be used, since it may permanently damage the equipment. Damage due to over fusing is not covered by the warranty.

RCI-2985DX
RCI-2995DX

CHAPTER 8
DIAGRAMS &
PARTS LIST

8.0 GENERAL

Information on most electrical and mechanical parts is included in the parts list. The reference designators are in alphanumeric order.

8.1 ORDERING REPLACEMENT PARTS

Parts orders should be referred to the parts department at:

* Ranger Communications, Inc.
401 W. 35th ST., # B,
NATIONAL CITY, CA 91950-7909

Tel: (619) 426-6440
Fax: (619) 426-3788

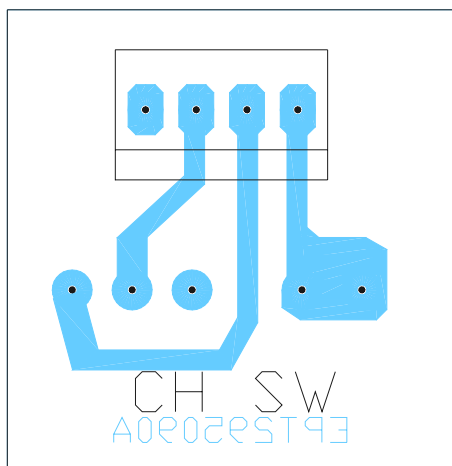

PART LIST:

RCI-2985DX / RCI-2995DX CH SW P.C.B

ITEM	REFERENCE NUMBER	RANGER PART	DESCRIPTION
------	------------------	-------------	-------------

		NUMBER	
1		EPT295090A	CH SW P.C.B
2	PCB CONN/S 3P (COPPER SIDE)	CC0501037L	0.01 μ F 50WV
3	CH SW	EWRT32097S	ROTARY SW
4	CH SW P.C.B	EX07N41216	PCB CONN/S 3PIN

REMARK:
COPPER SIDE (BLUE)

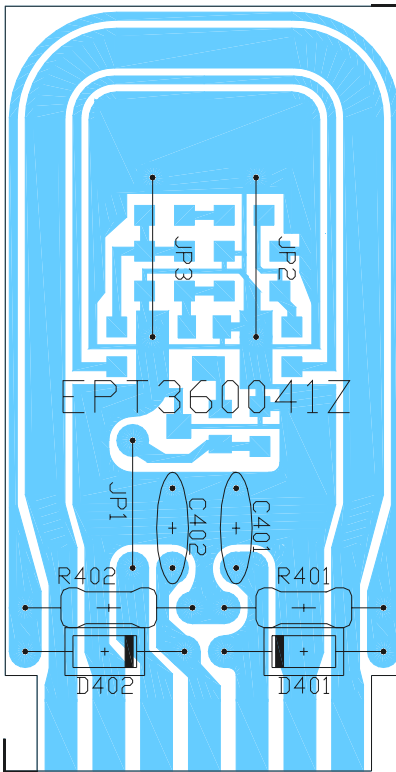

PART LIST:

RCI-2985DX SWR P.C.B

ITEM	REFERENCE NUMBER	RANGER PART NUMBER	DESCRIPTION
1		EPT360041Z	SWR P.C.B
2	R402	RCP141014Z	100 Ω 1/4W
3	R401	RCP141214Z	120 Ω 1/4W
4	C401,C402	CC0501037L	0.01μF 50WV
5	D401,D402	ED1N00060P	DIODE 1N60P
6	JP2,JP3	WX01070710	JUMPER WIRE

REMARK:

COPPER SIDE (BLUE)

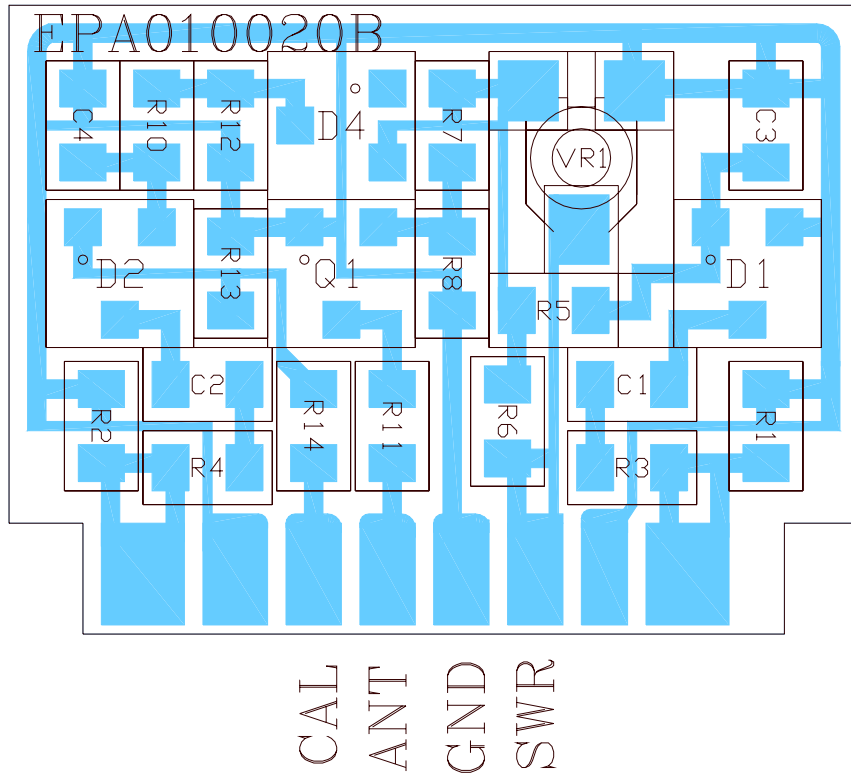

PART LIST:

RCI-2995DX SWR P.C.B

ITEM	REFERENCE NUMBER	RANGER PART NUMBER	DESCRIPTION
1		EPA010020B	SWR P.C.B
2	R5,R14,C4	RCY010004Z	0 Ω 0.1W
3	R1,R2	RCY011014Z	100 Ω 0.1W
4	R3,R4,R6	RCY014714Z	470 Ω 0.1W
5	C1,C2	CK1102AB7L	0.001μF 50WV
6	C3,R13	CK2104AB7R	0.1μF 25WV
7	D1,D2	EDHM0198SY	DIODE HSM198S
8	R11	ED1N04148Y	DIODE 1N4148

REMARK:

COPPER SIDE (BLUE)

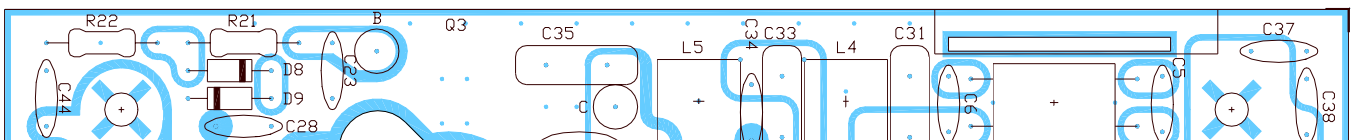

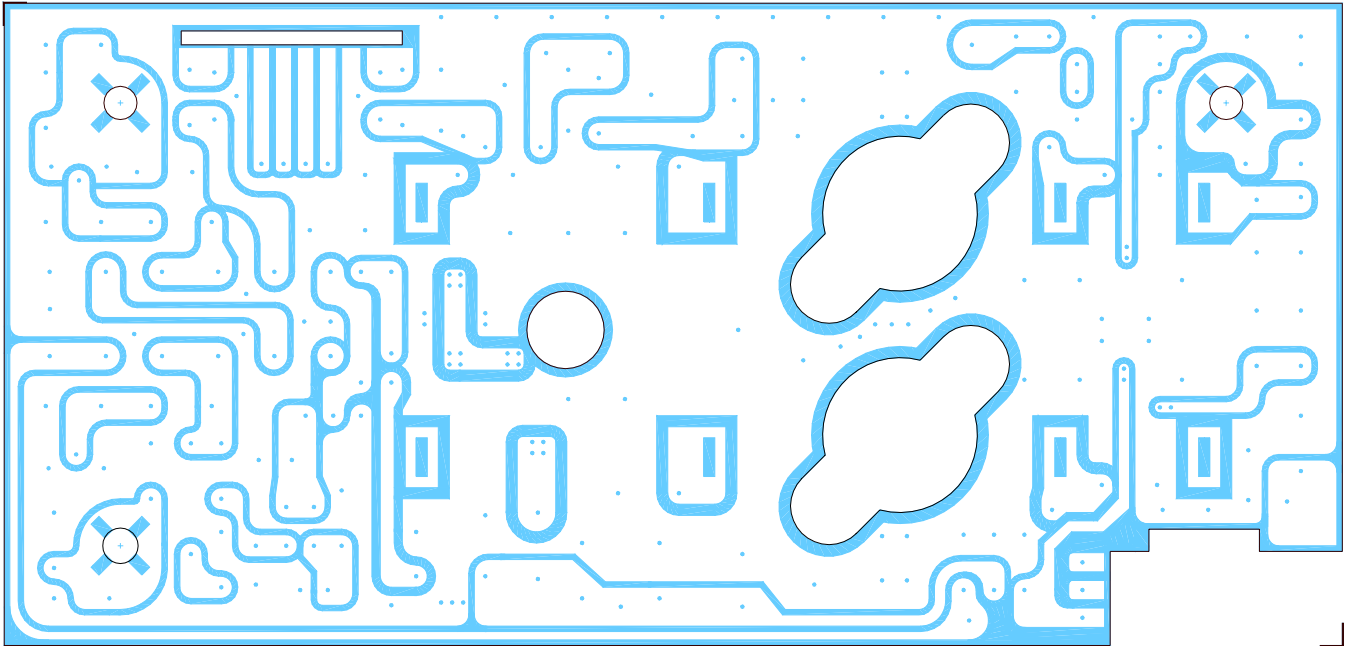

PART LIST:

RCI-2995DX NEW POWER P.C.B

ITEM	REFERENCE NUMBER	RANGER PART NUMBER	DESCRIPTION
1		EPA010010B	RF AMP P.C.B
2	Q3,Q4	T2SC02290Z	TR 2SC2290
3	Q5	T2SD02531Z	TR 2SD2531
4	R18,R19	RCM141004A	10 Ω 1/4W
5	R16	RCM141014A	100 Ω 1/4W
6	R22	RCM144714A	470 Ω 1/4W
ITEM	REFERENCE NUMBER	RANGER PART NUMBER	DESCRIPTION

7	R21	RCM141024A	1K Ω 1/4W
8	R14	RFP102714Z	270 Ω 1W
9	R15	RCP121034Z	10K Ω 1/2W
10	R23,R24	RFP204704Z	47 Ω 2W
11	C5,C6	CC0500201A	2PF 50WV
	C36	CC0503304A	33PF 50WV
12	C13	CC0501215A	120PF 50WV
13	C18,C19	CC0501515A	150PF 50WV
14	C9,C14	CC0505615G	560PF 50WV
15	C10,C23,C24,C25,C26, C27,C28,C29,C37,C38, C39,C40,C41,C42,C43, C44,C45,C47,C48	CC0501047L	0.1 μ F 50WV
16	C7,C8	CC5001037L	0.01 μ F 500WV
17	C34	CC5001204A	12PF 500WV
18	C32	CC5003904A	39PF 500WV
19	C31	CD3006804Z	68PF 300WV
20	C35	CD3008204Z	82PF 300WV
21	C16,C22,C23	CD3001514Z	150PF 300WV
22	C12	CE0502257Z	2.2 μ F 50WV
23	C30	CE0254777Z	470 μ F 25WV
24	Q2	TDTC0114ES	TR DTC114ES
25	D4,D7,D8,D9	ED1N04148Z	DIODE 1N4148
26	D10	EDLT6A400Z	DIODE LT6A400
27	L4,L5	ECSPG18382	SPRING COIL 1x6.5x6.5t
28	L2	ECBAD18571	BEAD COIL
29	L3	ECBAD18572	BEAD COIL
30	L1	ECCHK16142	CHOKE COIL 100 μ H
31	RF AMP P.C.B	ECRFZ10053	TDK BRAND CORE
32	T1	ECRFZ10184	RF COIL ASS'Y (#ST-182E-2)
33	T2	ECRFZ10185	RF COIL ASS'Y (#ST-182E-3)
34	RL1	EX05N40844	RELAY S2EB-12V
35	J1	EX07N41226	PCB CONN/S 2PIN
36	J2	EX07N48490	PCB CONN/S 4PIN
37	B+,B-	GZZZ50011Z	C PIN
38	I/P,O/P	GZZZ50062Z	V TYPE JACK
39	RF AMP P.C.B	JS052606MN	SET SCREW
40	Q5	JS013008TH	SET SCREW

REMARK:

TOP: COMPONENT SIDE (WHITE)

BOTTOM: COPPER SIDE (WHITE)

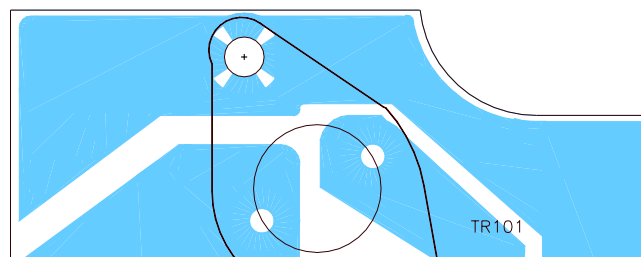

PART LIST:

RCI-2995DX POWER / TR P.C.B

ITEM	REFERENCE NUMBER	RANGER PART NUMBER	DESCRIPTION
1		EPTSSB100B	POWER / TR P.C.B
2	TR101,TR102	TZ2N03771Z	TR 2N5301
3	TR101,TR102	PA0100010A	MICA INSULATOR

REMARK:

COPPER SIDE (BLUE)

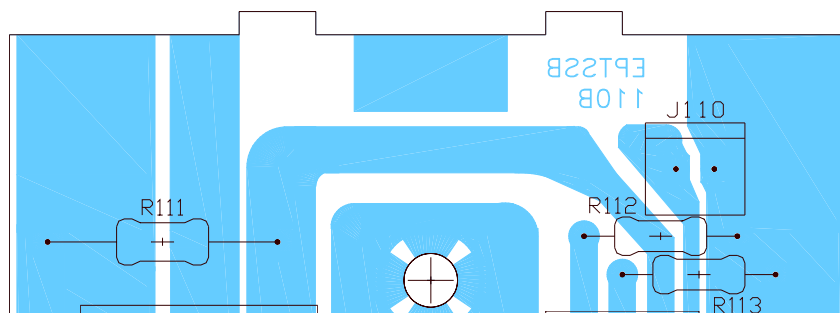

PART LIST:

RCI-2995DX REGULATOR P.C.B

ITEM	REFERENCE NUMBER	RANGER PART NUMBER	DESCRIPTION
1		EPTSSB110B	REGULATOR P.C.B
2	R112	RCM141094A	1 Ω 1/4W
3	R113	RCM141024A	1K Ω 1/4W
4	R111	RCP104704Z	47 Ω 1W
5	C111,C112,C113,C115, C116,C117,C118	CC0501037L	0.01 μ F 50WV
6	C114	CC0501047L	0.1 μ F 50WV
7	D111	EDZD05519Z	ZENER DIODE 5.1V 1/2W
8	TR111	T2SB00754Y	TR 2SB754Y
9	IC111	ENJR07808A	IC NJM7808A 3PIN
10	VR111	RE10100018	S/R/F 100 Ω
11	B1,B2,B3,B4,B6, B7,B8,B9	GZZZ50011Z	C PIN

REMARK:

COPPER SIDE (BLUE)

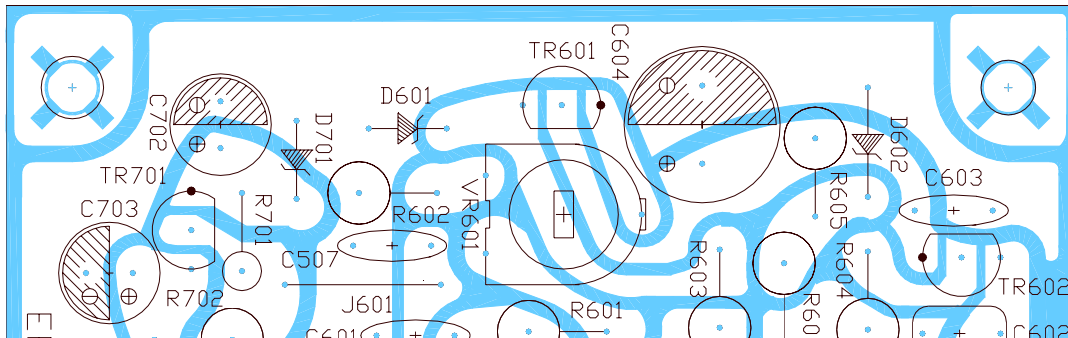

PART LIST:

RCI-2985DX POWER P.C.B

ITEM	REFERENCE NUMBER	RANGER PART NUMBER	DESCRIPTION
1		EPT0SSB62A	POWER P.C.B
2	R607	RCU141034Z	10K Ω 1/4W
3	R605	RCP101014Z	100 Ω 1W
4	R606	RCP102214Z	220 Ω 1W
5	R602,R603	RCP108214Z	820 Ω 1W
6	R601	RCP101224Z	1.2K Ω 1W
7	C602	CC0501036S	0.01 μ F 50WV
8	C506,C507,C601	CC0501037L	0.01 μ F 50WV
9	C603	CC0504737L	0.047 μ F 50WV
10	C604	CE0351077Z	100 μ F 35WV
11	TR602	T2SD00471K	TR 2SD471K
12	TR601	T2SC05395Z	TR 2SC05395E
13	D601	EDZD10569Z	ZENER DIODE 5.6V 1W
14	D602	EDZD10160Z	ZENER DIODE 16V 1W
15	FUSE	EX02N40210	FUSE 16V 7A
16	VR601	RE50100063	S/F/R 500 Ω
17	FUSE	GZZZ50043Z	FUSE BRACKET
17	R604	WX01070705	JUMPER WIRE
18	J601	WX01070710	JUMPER WIRE

REMARK:

COPPER SIDE (WHITE)

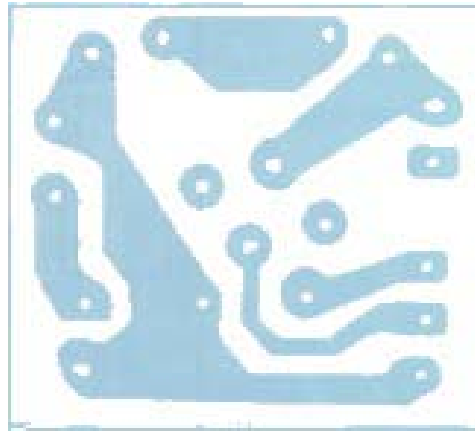
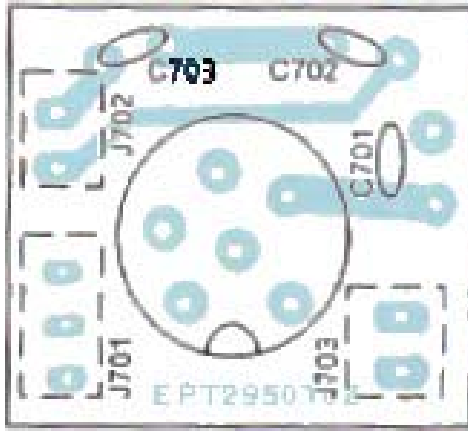

PART LIST:

RCI-2985DX / RCI-2995DX MIC P.C.B

ITEM	REFERENCE NUMBER	RANGER PART NUMBER	DESCRIPTION
1		EPT295070Z	MIC P.C.B
2	C701,C702,C703	CCM501025T	0.001 μ F 50WV
3	J702,J703	EX07N48152	PCB CONN/S 2PIN
4	J701	EX07N48244	PCB CONN/S 3PIN
5	MIC P.C.B	EX06N41111	MIC JACK

REMARK:

LEFT: COMPONENT SIDE (BLUE)

RIGHT: COPPER SIDE (BLUE)

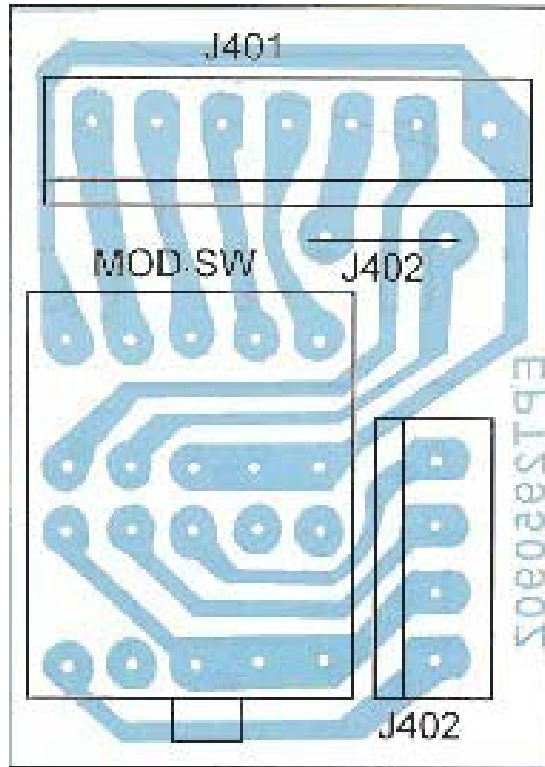

PART LIST:

RCI-2985DX / RCI-2995DX BAND P.C.B

ITEM	REFERENCE NUMBER	RANGER PART NUMBER	DESCRIPTION
1		EPT295090Z	BAND P.C.B
2	MOD SW	EWRT32053S	ROTARY SW
3	J402	EX07N41216	PCB CONN/S 3PIN
4	J401	EX07N41261	PCB CONN/S 7PIN
5	J403	WX01070706	JUMPER WIRE

REMARK:

COPPER SIDE (BLUE)

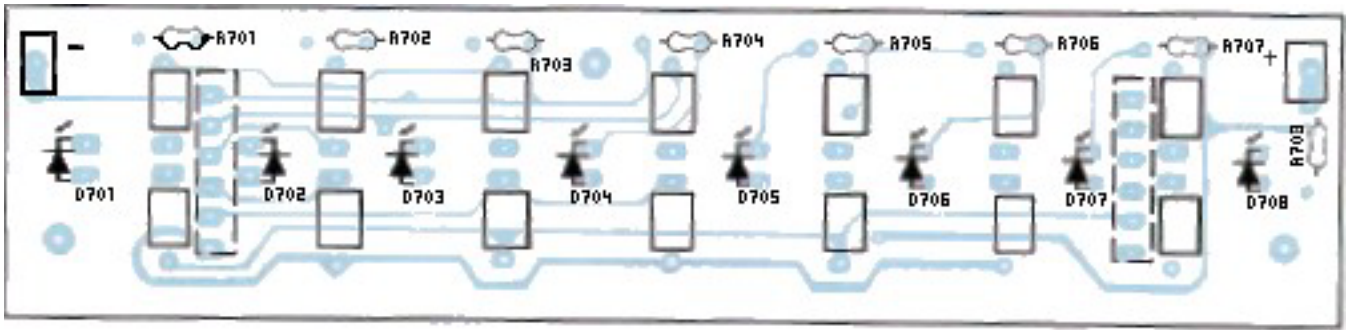

PART LIST:

RCI-2985DX / RCI-2995DX KEY P.C.B

ITEM	REFERENCE NUMBER	RANGER PART NUMBER	DESCRIPTION
1		EPT295031Z	KEY P.C.B
2	R701,R702,R703,R704, R705,R706,R707,R708	RCP161524Z	1.5K Ω 1/16W
3	KEY SW P.C.B x 14 pcs	EWPS33042X	TACT SW
4	D701,D702,D703,D704, D705,D706,D707,D708	EX01N40064	LED (WHITE)
5	KEY SW x 2 pcs	EX07N41266	PCB CONN/S 6PIN

REMARK:

TOP: COMPONENT SIDE (BLUE)

BOTTOM: COPPER SIDE (BLUE)

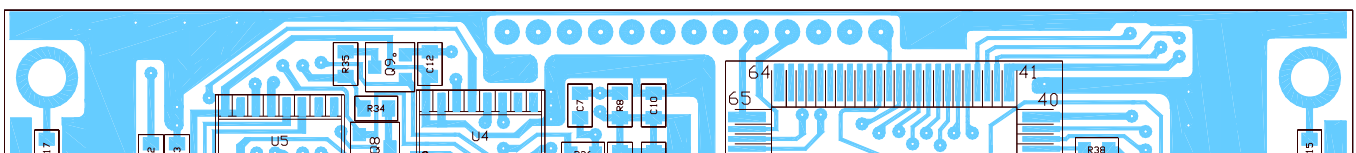

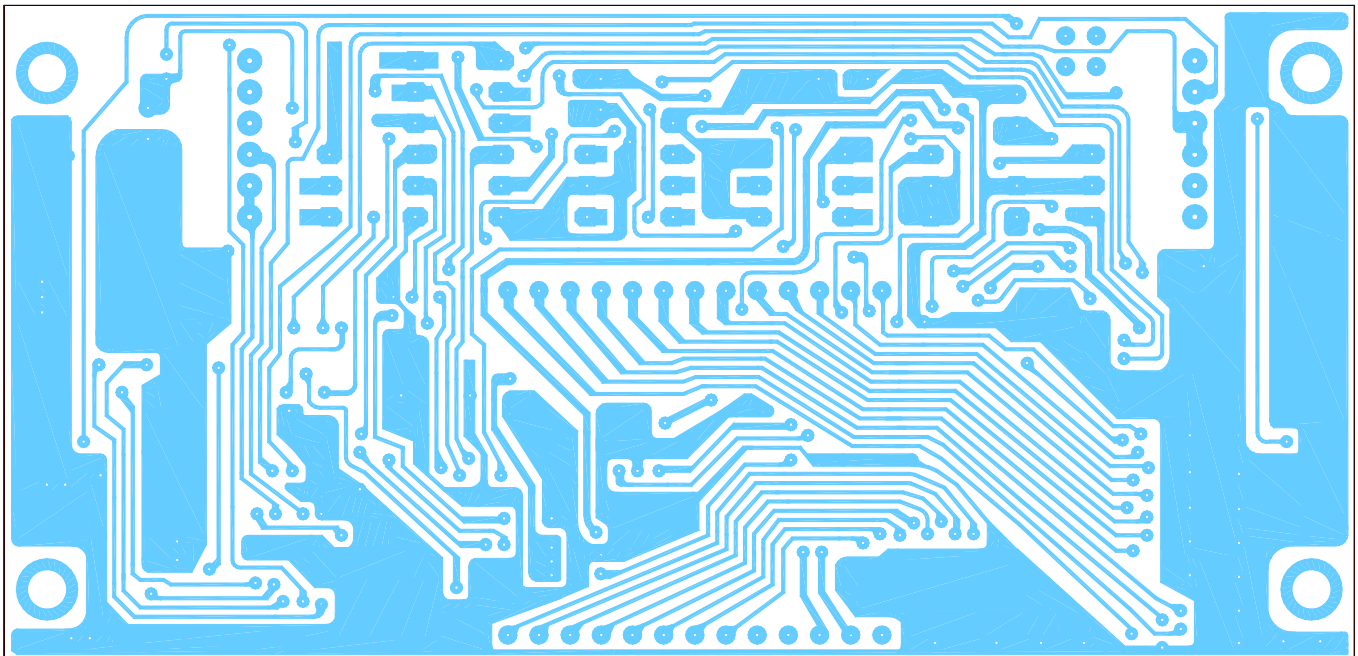

PART LIST:

RCI-2985DX / RCI-2995DX CPU P.C.B

ITEM	REFERENCE NUMBER	RANGER PART NUMBER	DESCRIPTION
1		EPT695041Z	CPU P.C.B
2	C619	CE0254767Z	47 μ F 25WV
3	C604	CE0102277Z	220 μ F 10WV
4	DISPLAY	EX03N40460	LCD DISPLAY
5	X601	EX14N46510	CERAMIC RESONATOR
6	BU601	EX14N46511	BUZZER
7	CN602,CN608	EX07N41226	PCB CONN/S 2PIN
ITEM	REFERENCE NUMBER	RANGER PART NUMBER	DESCRIPTION
8	CN603,CN604,CN605,	EX07N41216	PCB CONN/S 3PIN

	CN610,CN611		
9	CN601	EX07N41250	PCB CONN/S 4PIN
10	CN606,CN607,SK601, SK602	EX07N41266	PCB CONN/S 6PIN
11	JP1/JP2(J5)	EX07N48440	PCB CONN/H 4PIN
12	CPU P.C.B	EX01N40119	LED BACK LIGHT
13	R604,LP601	RCY053304Z	33 Ω 0.5W
14	R606	RCY055604Z	56 Ω 0.5W
15	R636,R638,R633	RCY010004Z	0 Ω 0.1W
16	R632	RCY011014Z	100 Ω 0.1W
17	R635	RCY016814Z	680 Ω 0.1W
18	R634	RCY011024Z	1K Ω 0.1W
19	R607	RCY014724Z	4.7K Ω 0.1W
20	R605	RCY018224Z	8.2K Ω 0.1W
21	R601,R603,R610,R611, R627,R631	RCY011034Z	10K Ω 0.1W
22	R616,R618,R620,R623, R624	RCY012734Z	27K Ω 0.1W
23	R629	RCY013334Z	33K Ω 0.1 W
24	R609,R612,R613,R628	RCY014734Z	47K Ω 0.1W
25	R615,R617,R619,R621, R622,R625,R626	RCY015634Z	56K Ω 0.1W
26	R614	RCY011044Z	100K Ω 0.1W
27	R630	RCY011544Z	150K Ω 0.1W
28	R608	RCY014744Z	470K Ω 0.1W
29	R602	RCY011054Z	1M Ω 0.1W
30	C601,C606	CK1330AB4A	33PF 50WV
31	C624,C625	CK1102AB7L	0.001 μ F 50WV
32	C608,C609,C620,C621, C622,C623	CK1103AB5X	0.01 μ F 50WV
33	C610,C611,C612,C613, C614,C615,C616,C617, C605	CK1104AB7R	0.1 μ F 50WV
34	C607	CK1224AB7R	0.22 μ F 50WV
35	C602,C603	CK5105AB7R	1 μ F 16WV
36	U601	YN2950DXSP	IC HD404818G17FS 80PIN
37	U602	YNMA08005M	IC AN8005M 3PIN
38	U604,U605	YNR004094B	IC BU4094BF 16PIN
39	U606	YNEX93L46P	IC P93L46 8PIN
40	Q602,Q604	TY2SDO999Z	TR 2SD999
41	Q601,Q603,Q605,Q606, Q607	TY2SC2712G	TR 2SC2712
42	Q608,Q609	TYZRN1403Z	TR RN1403
43	D601	ED1N04148Y	DIODE 1N4148
44	D602,D605,D606,D607	EDSS00355Y	DIODE 1SS355

REMARK:

TOP: COMPONENT SIDE (BLUE)

BOTTOM: COPPER SIDE (BLUE)

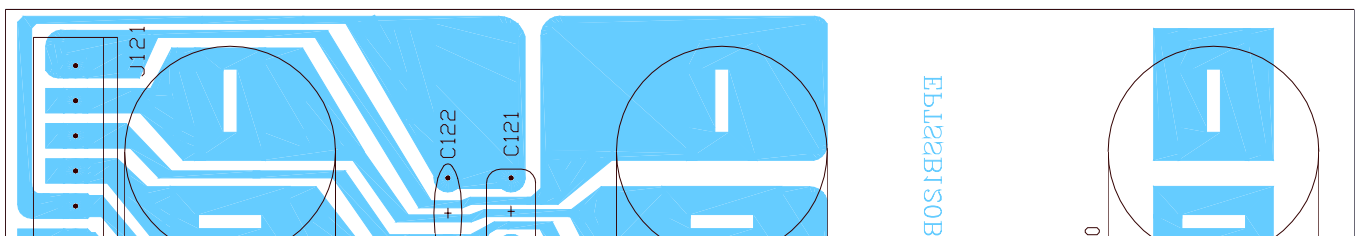

PART LIST:

RCI-2985DX / RCI-2995DX TIME P.C.B

ITEM	REFERENCE NUMBER	RANGER PART NUMBER	DESCRIPTION
1		EPTSSB120B	TIME P.C.B
2	C120	CC0501027L	0.001 μ F 50WV
3	RF POWER	RV50303461	VR 50KA
4	J121	EX07N48204	PCB CONN/S 2PIN

REMARK:

COPPER SIDE (BLUE)

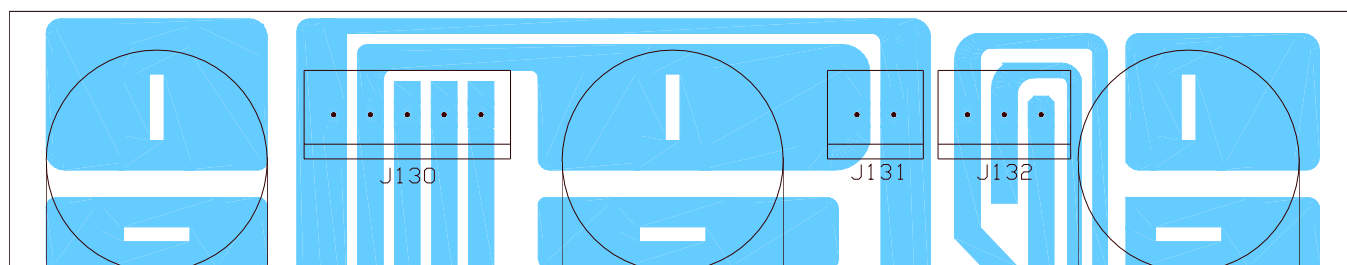

PART LIST:

RCI-2985DX / RCI-2995DX AF/SQ/CLR P.C.B

ITEM	REFERENCE NUMBER	RANGER PART NUMBER	DESCRIPTION
1		EPTSSB130B	AF/SQ/CLR P.C.B
2	C130,C131,C132,C133	CC0501027L	0.001μF 50WV
3	AF GAIN	RV50303461	VR 50KA
4	SQ	RV50303463	VR 50KB
5	CLARIFIER	RV10203465	VR 1KB
6	J131	EX07N48204	PCB CONN/S 2PIN
7	J132	EX07N48546	PCB CONN/S 3PIN
8	J130	EX07N48497	PCB CONN/S 5PIN
9	J133	WX01070705	JUMPER WIRE

REMARK:

COPPER SIDE (BLUE)

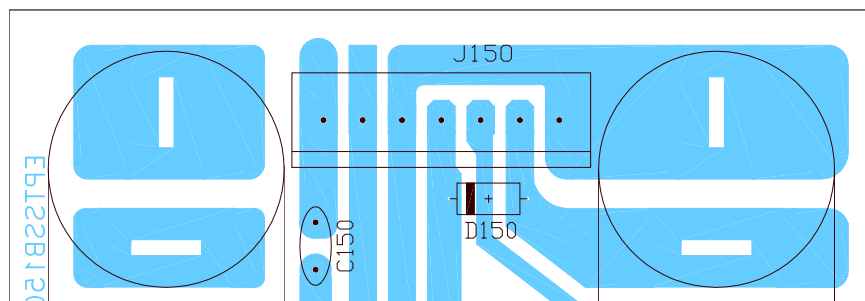

PART LIST:

RCI-2985DX / RCI-2995DX CALIBRATE P.C.B

ITEM	REFERENCE NUMBER	RANGER PART NUMBER	DESCRIPTION
1		EPTSSB150B	CALIBRATE P.C.B
2	D150,D151	ED1N04148Z	DIODE 1N4148
3	CALIBRATE	RV50203466	VR 5KB/SW
4	J150	EX07N48497	PCB CONN/S 5PIN

REMARK:

COPPER SIDE (BLUE)

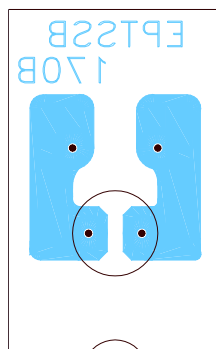

PART LIST:

RCI-2985DX / RCI-2995DX LED P.C.B

ITEM	REFERENCE NUMBER	RANGER PART NUMBER	DESCRIPTION
1		EPTSSB170B	LED P.C.B
2	LED P.C.B	EX01N40010	LED (RED)

REMARK:

COPPER SIDE (BLUE)

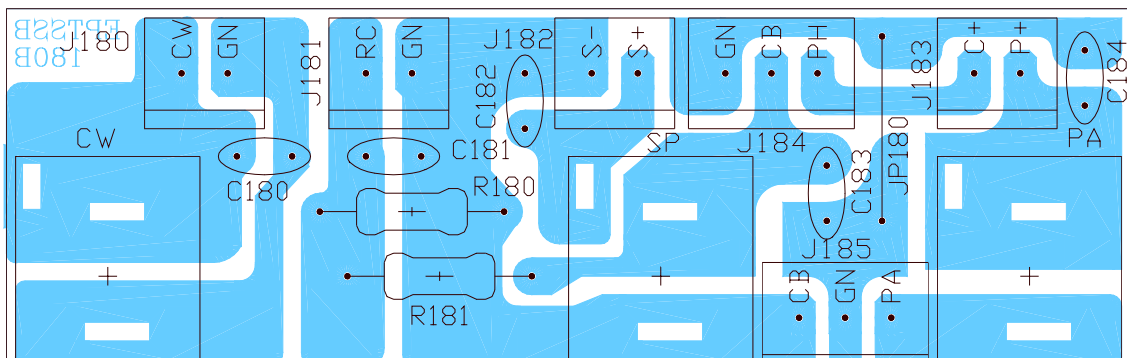

PART LIST:

RCI-2985DX / RCI-2995DX CW/SP/PA JACK P.C.B

ITEM	REFERENCE NUMBER	RANGER PART NUMBER	DESCRIPTION
1		EPTSSB180B	CW/SP/PA JACK P.C.B
2	R180,R181	RCM141034A	10K Ω 1/4W
3	C180,C181,C182,C183, C184	CC0501027L	0.001 μ F 50WV
4	CW,PA,SP	EX06N41034	EAR JACK
5	J180,J181,J182,J183	EX07N41226	PCB CONN/S 2PIN
6	J184,J185	EX07N41216	PCB CONN/S 3PIN
7	JP180	WX01070710	JUMPER WIRE

REMARK:

COPPER SIDE (BLUE)

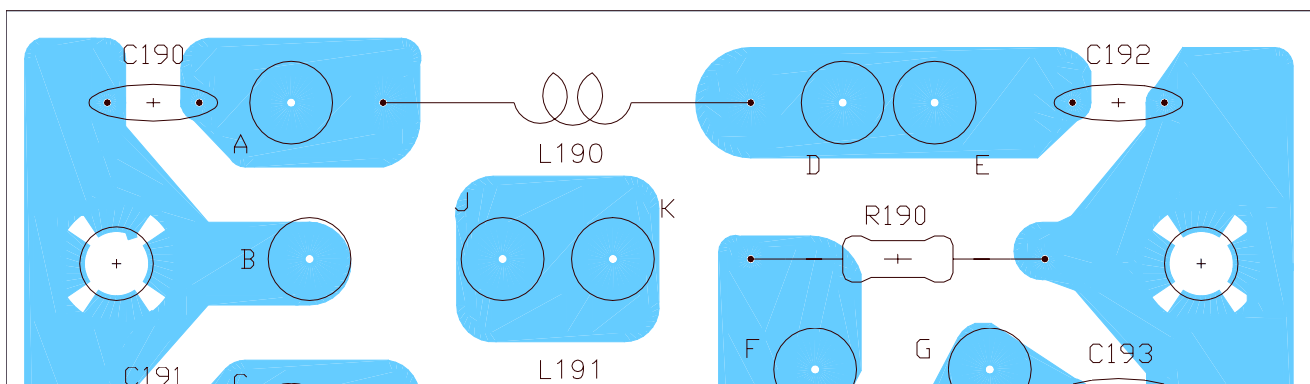

PART LIST:

RCI-2995DX POWER INPUT P.C.B

ITEM	REFERENCE NUMBER	RANGER PART NUMBER	DESCRIPTION
1		EPTSSB190B	POWER INPUT P.C.B
2	R190	RCP102254Z	2.2M Ω 1W
3	C190,C191,C192,C193	CX0071027Z	HV DISC 0.001 μ F
4	L190,L191	ECCHK16098	CHOKE COIL 6.8 μ H
5	A,B,C,D,E,F,G,H,I,J,K	GZZZ50011Z	C PIN

REMARK:

COPPER SIDE (BLUE)

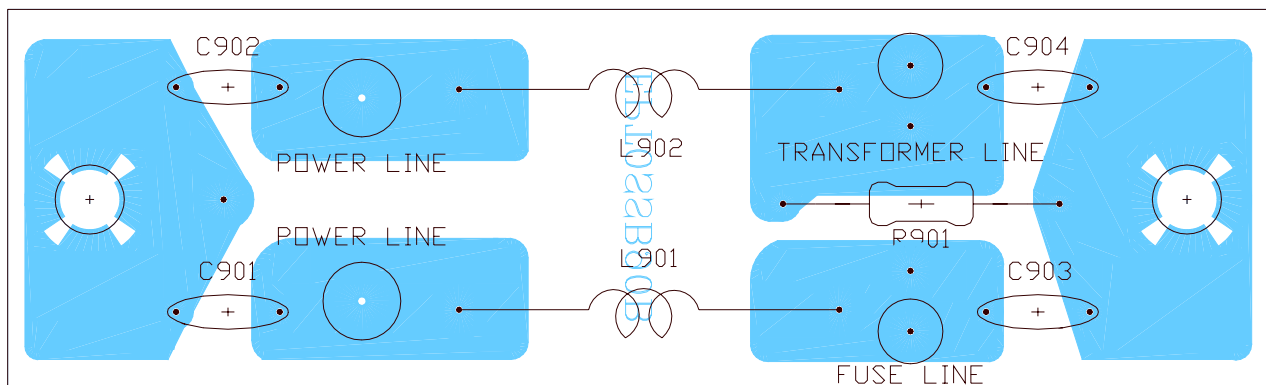

PART LIST:

RCI-2985DX POWER INPUT P.C.B

ITEM	REFERENCE NUMBER	RANGER PART NUMBER	DESCRIPTION
1		EPT0SSB90B	POWER INPUT P.C.B
2	R901	RCP122254Z	2.2M Ω 1/2W
3	C901,C901,C902,C903, C904	CX0071027Z	HV DISC 0.001 μ F
4	L901,L902	ECCHK16098	CHOKE COIL 6.8 μ H
5	L901,L902	WX0008020A	TUBE

REMARK:

COPPER SIDE (BLUE)

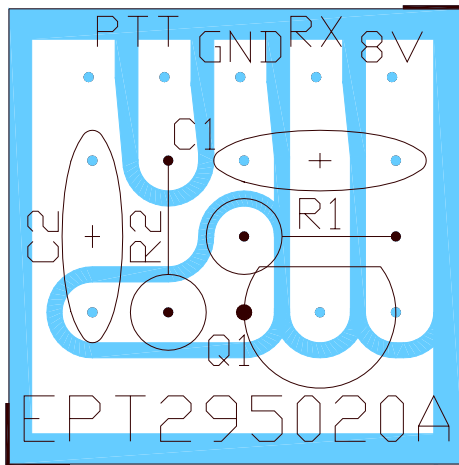

PART LIST:

RCI-2985DX / RCI-2995DX PTT P.C.B

ITEM	REFERENCE NUMBER	RANGER PART NUMBER	DESCRIPTION
1		EPT295020A	PTT P.C.B
2	R1	RCU144724Z	4.7K Ω 1/4W
3	R2	RCU141034Z	10K Ω 1/4W
4	C1	CC0501037L	0.01 μ F 50WV
5	Q1	T2SA00733P	TR 2SA733P
6	PTT P.C.B	WM0407005Z	LEAD WIRE (YELLOW)
7	PTT P.C.B	WM0607005Z	LEAD WIRE (BLUE)
8	PTT P.C.B	WM0207005Z	LEAD WIRE (RED)
9	PTT P.C.B	WL0440005Z	LEAD WIRE (YELLOW)
10	PTT P.C.B	XZZZ90392Z	SP SPACER

REMARK:

COPPER SIDE (WHITE)

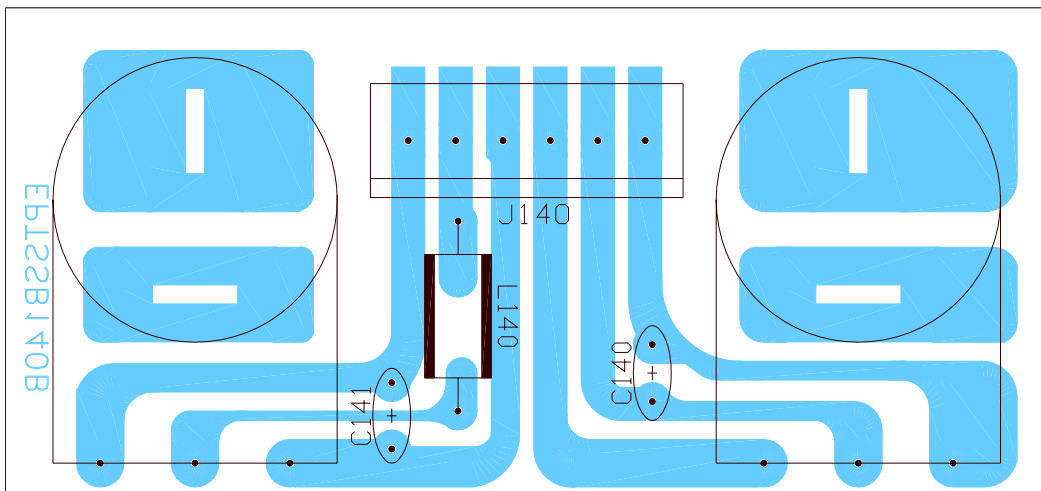

PART LIST:

RCI-2985DX / RCI-2995DX RF/MIC GAIN P.C.B

ITEM	REFERENCE NUMBER	RANGER PART NUMBER	DESCRIPTION
1		EPTSSB140B	RF/MIC GAIN P.C.B
2	C140,C141	CC0501027L	0.001 μ F 50WV
3	L140	ECBAD18526	BEAD COIL 3.5x6x1.2
4	MIC GAIN	RV10203464	VR 1KA
5	RF GAIN	RV10203465	VR 1KB
6	J140	EX07N41280	PCB CONN/S 6PIN

REMARK:

COPPER SIDE (BLUE)

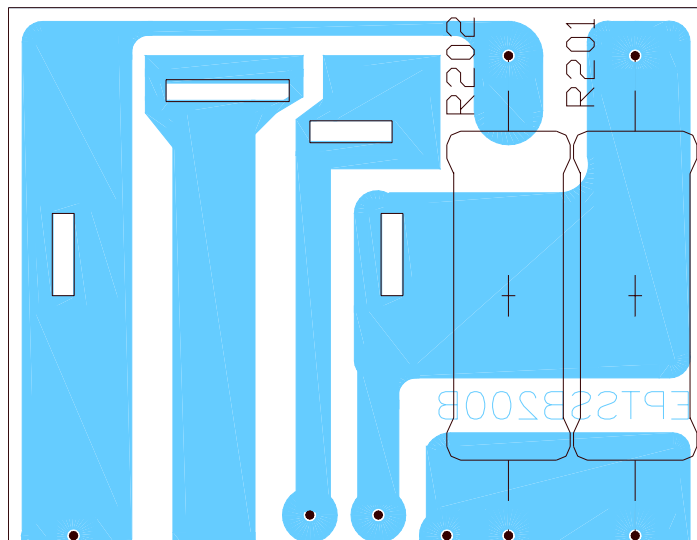

PART LIST:

RCI-2985DX / RCI-2995DX EAR JACK 4P P.C.B

ITEM	REFERENCE NUMBER	RANGER PART NUMBER	DESCRIPTION
1		EPTSSB200B	EAR JACK 4P P.C.B
2	R201,R202	RCP104704Z	47 Ω 1W
3	EARJACK 4P	EX06N41221	PHONE JACK

REMARK:

COPPER SIDE (BLUE)

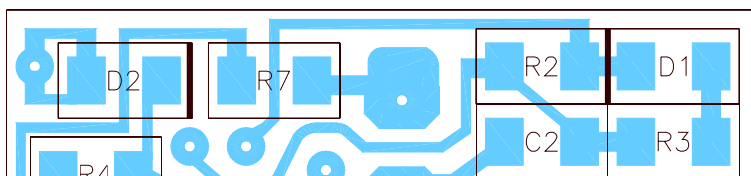
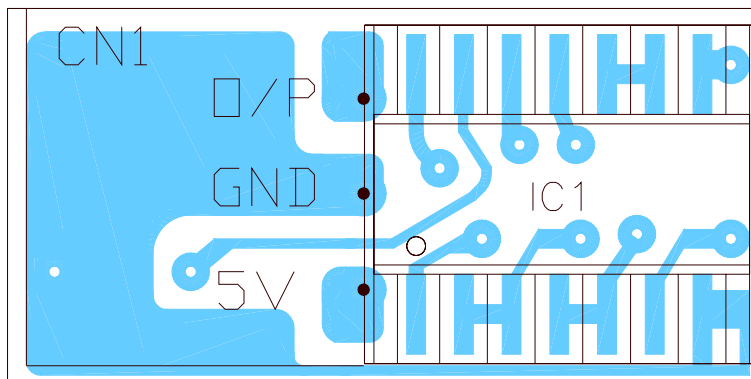

PART LIST:

RCI-2985DX / RCI-2995DX E-KEY P.C.B

ITEM	REFERENCE NUMBER	RANGER PART NUMBER	DESCRIPTION
1		EPT695020Z	E-KEY P.C.B
2	R6	RCY011014Z	100 Ω 0.1W
3	R3,R4,R7	RCY011024Z	1K Ω 0.1W
4	R1	RCY011034Z	10K Ω 0.1W
5	R5	RCY014734Z	47K Ω 0.1W
6	R2	RCY015644Z	560K Ω 0.1W
7	C1,C4	CK1103AB5X	0.01μF 50WV
8	C2,C3	CK1224AB7R	0.22μF 50WV
9	D1,D2	EDSS00355Y	DIODE 1SS355
10	IC1	YNTA4069FN	IC TC4069UBFN 14PIN
11	CN1	EX07N49161	WIRE CONN/H 3PIN

REMARK:

TOP: COMPONENT SIDE (BLUE)

BOTTOM: COPPER SIDE (BLUE)

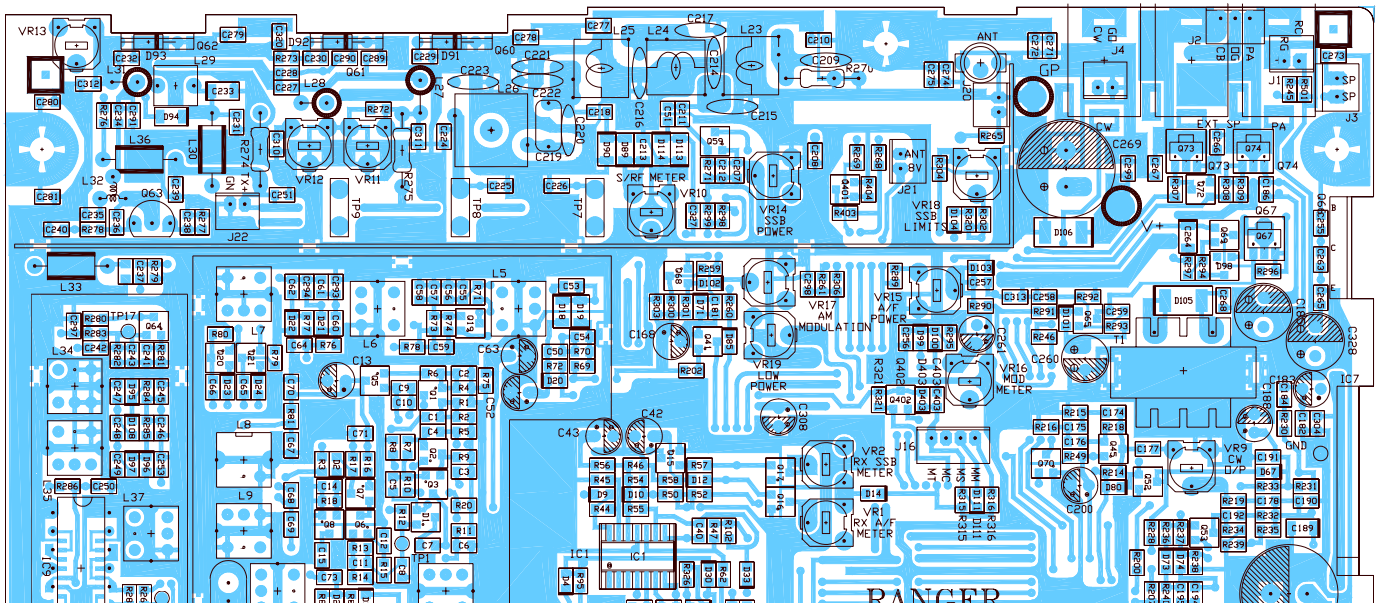

RCI-2985DX / RCI-2995DX MAIN PCB

REMARK:
COMPONENT SIDE (BLUE)

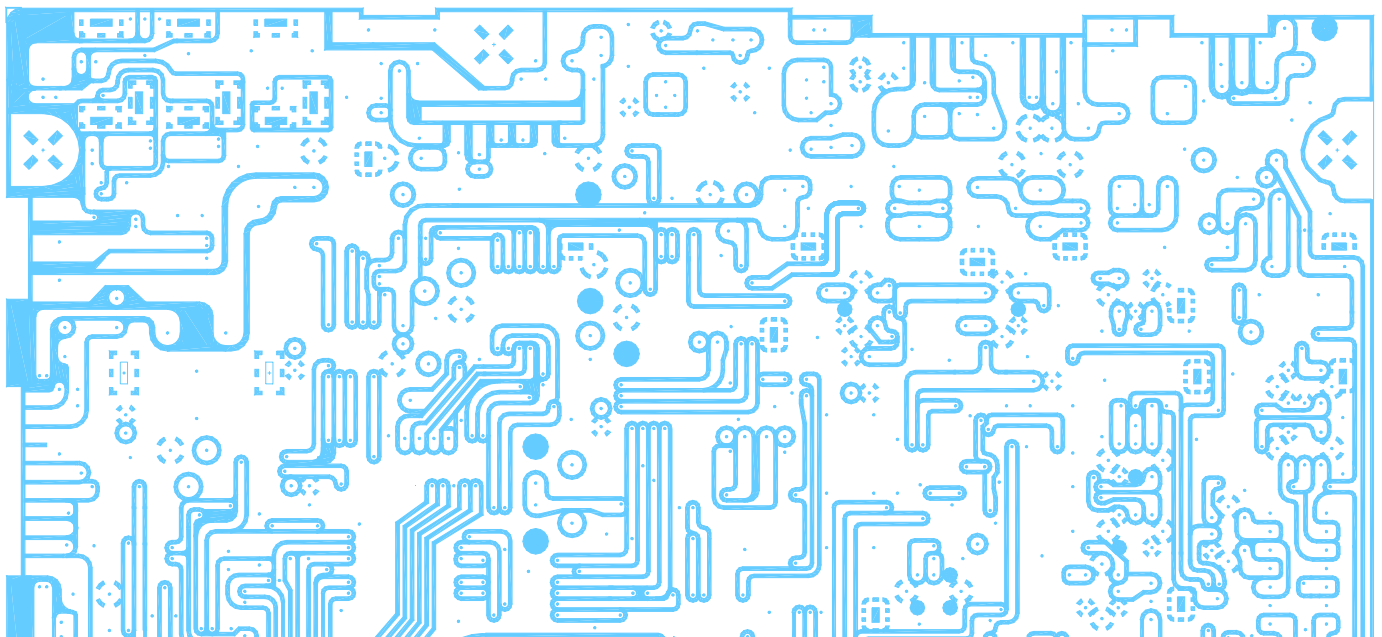

RCI-2985DX / RCI-2995DX MAIN PCB

REMARKS:
COPPER SIDE (BLUE)

PART LIST
RCI-2985DX MAIN PCB

REFERENCE NUMBER	RANGER PART NO.	DESCRIPTION
	EPT695011A	MAIN P.C.B
R316,317,318,321,328,403,177	RCY010004Z	0Ω 0.1W
R277	RCY014794Z	4.7Ω 0.1W
R179,144	RCY011004Z	10Ω 0.1W
R293	RCY011504Z	15Ω 0.1W
R272,273	RCY012204Z	22Ω 0.1W
R246	RCY013304Z	33Ω 0.1W
R115,226,281	RCY014704Z	47Ω 0.1W
R227,231	RCY015604Z	56Ω 0.1W
R11,105	RCY016804Z	68Ω 0.1W
R3,5,8,32,36,78,97,145,172,143,182,186,286,289,154,158	RCY011014Z	100Ω 0.1W
R35,104,276,280,136,253	RCY011514Z	150Ω 0.1W
R23	RCY011814Z	180Ω 0.1W

R166,171,190,130,262	RCY012214Z	220Ω 0.1W
R33,103	RCY012714Z	270Ω 0.1W
R6,10,16,279,282,306	RCY013314Z	330Ω 0.1W
R148,170,202,250,259,304,24,116	RCY014714Z	470Ω 0.1W
R146,167,263,292	RCY015614Z	560Ω 0.1W
R4,50,90,224	RCY016814Z	680Ω 0.1W
R74	RCY018214Z	820Ω 0.1W
R19,22,64,67,71,75,82,101,117,122,127,149,150,152,174,178,192,199,207,213,225,233,244,255,257,258,266,267,268,269,271,294,297,307,308,322,326,134,329,96,D99,R287	RCY011024Z	1KΩ 0.1W
R91,205	RCY011224Z	1.2KΩ 0.1W
R56,89,100,220,221,260,278,283,299,79,80	RCY011524Z	1.5KΩ 0.1W
R235	RCY011824Z	1.8KΩ 0.1W
R27,30,70,73,95,209,214,254,288,302,310,311,320	RCY012224Z	2.2KΩ 0.1W
R9,25,31	RCY012724Z	2.7KΩ 0.1W

R18,28,66,113,184,204,230,298,305	RCY013324Z	3.3KΩ 0.1W
R52,58	RCY013924Z	3.9KΩ 0.1W
R29,72,86,139,140,141,142,159,162,163,206,211,212,215,216,256,261,327,247	RCY014724Z	4.7KΩ 0.1W
R87,94,201,290,291	RCY015624Z	5.6KΩ 0.1W
R14,42,43,69,85	RCY016824Z	6.8KΩ 0.1W
R92,300	RCY018224Z	8.2KΩ 0.1W
R1,13,17,20,38,39,57,65,68,83,88,118-121,123,126,157,164,165,168,173,187,188,194,217,223,135,137,239,240-243,153,248,251,252,296,301,309,313,124,128,131,265,323,324,160,249,245,501	RCY011034Z	10KΩ 0.1W
R191,138	RCY011234Z	12KΩ 0.1W
R193	RCY011534Z	15KΩ 0.1W
R93,110,222,155,236,40,41	RCY012234Z	22KΩ 0.1W
R2,264,228	RCY013334Z	33KΩ 0.1W
R46	RCY013934Z	39KΩ 0.1W
R7,34,62,63,99,132,175,198,229,234,319,200	RCY014734Z	47KΩ 0.1W
R26,107,112,181	RCY016834Z	68KΩ 0.1W
R45	RCY018234Z	82KΩ 0.1W
R12,44,48,49,51,53,76,77,106,109,114,169,176,195,197,232,238,284,285,303,312,125	RCY011044Z	100KΩ 0.1W
R156	RCY011544Z	150KΩ 0.1W
R183	RCY011844Z	180KΩ 0.1W
R21,47,59,84,147,151,210,218,111	RCY012244Z	220KΩ 0.1W
R54,55,185,189	RCY012744Z	270KΩ 0.1W
R15,37,196,219	RCY014744Z	470KΩ 0.1W
R102	RCY018244Z	820KΩ 0.1W
R108,161,133	RCY011054Z	1MΩ 0.1W
R208	RCY011554Z	1.5MΩ 0.1W
C248	CK1059AB1A	0.5PF 50WV
C236,249,61	CK1010AB1A	1PF 50WV
C208,218,211	CK1030AB1A	3PF 50WV
C68,69,88,95,121,253,86,148,155	CK1050AB1A	5PF 50WV
C108	CK1080AB2A	8PF 50WV
C1,57,142,247	CK1100AB2A	10PF 50WV
C98,117	CK1150AB4A	15PF 50WV
C51	CK1180AB4A	18PF 50WV
C150,133	CK1220AB4A	22PF 50WV
C44,242	CK1270AB4A	27PF 50WV
C19,30,120,136,89	CK1330AB4A	33PF 50WV
L37(PIN4-6)	CK1330AA4A	33PF 50WV
C300,159,237	CK1470AB4A	47PF 50WV
C115,243	CK1680AB4A	68PF 50WV
C8,212	CK1820AB4A	82PF 50WV
C4,79,114,139,160,301,327	CK1101AB5A	100PF 50WV
C143	CK1121AB5A	120PF 50WV
C101	CK1151AB5A	150PF 50WV
C35,131	CK1221AB5A	220PF 50WV
C39	CK1271AB5A	270PF 50WV
C11,14	CK1331AB5A	330PF 50WV
C60,62,227,228	CK1471AB5A	470PF 50WV
C29	CK1561AB5A	560PF 50WV
C206	CK1390AB4D	39PF 50WV
C291	CK1100AB2G	10PF 50WV
C119	CK1330AB4G	33PF 50WV
C18,118,135	CK1680AB4G	68PF 50WV
C134	CK1101AB5G	100PF 50WV
C202,205	CK1151AB5G	150PF 50WV
C17	CK1271AB5G	270PF 50WV
C203	CK1331AB5G	330PF 50WV

C20,100	CK1391AB5G	390PF 50WV
C289,290	CK1561AB5G	560PF 50WV
C256	CK1103AB7A	0.01μF 50WV
C48,64,85,104,124,288,182,210,229,230,231,239,245,246,257,263,287,304,326,112,122,146,152,225,271,275,278,282,285,286,295,302,156,279,280,111,307,309,310,311,312,313,320	CK2104AB7R	0.1μF 25WV
C2,3,6,9,15,21,22,25,33,34,37,59,65-67,73,76,87,92,96,97,105,106,324,116,123,132,141,70,325,145,149,153,158,175,176,177,193,196,197,201,207,224,226,232,234,235,238,240,250,251,254,255,268,292,297-299,303,190,281,38,82,99,71,403	CK1103AB5X	0.01μF 50WV
C7,31,36,55,58,83,93,107,267,138,330,178,181,191,192,204,259,265,266	CK1102AB7L	0.001μF 50WV
C5,16,23,26,41,56,74,75,77,78,81,157,162,170,199,258,262,272,273,274,277,283,284,296,80	CK1473AB7R	0.047μF 50WV
C10	CK2474AB7R	0.47μF 25WV
C144	CK5475AA7R	4.7μF 16WV
C47,49,165,174,110,127	CK1223AB6U	0.022μF 50WV
C171	CK1153AB6U	0.015μF 50WV
C12	CK1222AB7R	0.0022μF 50WV
C40,50,53,54,172,173,241,184	CK1472AB6U	0.0047μF 50WV
C186	CK2224AB7R	0.22μF 25WV
C169,264,233	CK5225AA7R	2.2μF 16WV
C32,84,126,151,179,180,194,195,306,94	CK5105AB7R	1μF 16WV
C130,322	CTY161046Z	0.1μF 16WV
C163	CTY162246Z	0.22μF 16WV
C164,167,213,109,125,137,147	CTY161056Z	1μF 16WV
C129	CTY162256Z	2.2μF 16WV
C189,140,323,46	CTY164756Z	4.7μF 16WV
IC4	YNMA08005M	IC AN8005M-E2
IC1	YNJR00324M	IC NJM324M
IC6	YNJR04558M	IC NJM4558M
IC3	YNJR03404A	IC NJM3404M
IC2	YNMC45162D	IC MC145162D
IC9	YNSM6130X4	IC TDA6130
Q19,64	TY2SC3356Z	TR 2SC3356
Q47,49,67	TY2SB0798Z	TR 2SB798DL
Q3,5,6,8,15,18,30,35,40,43,44,45,48,50,53,55,57,65,68,69,71,28	TY2SC2712G	TR 2SC2712GR
Q7,41	TY2SA1298Y	TR 2SA1298Y
Q1,2,9,10,11,12,13,14,22,23,25,29,32,33,34,36,37,38,58,59,24	TY2SC2714Z	TR 2SC2714
Q73,74	TYTN2510N8	TR TN2510N8
Q16,17,26,27,52,54,56,70,72,76	TYZRN1403Z	TR RN1403
Q42,46	TYZRN2403Z	TR RN2403
Q20,21	FY2SK0302Z	F.E.T 2SK302
D1,11	EDSS00226Y	DIODE 1SS226
D82	EDSS00314Y	DIODE 1SS314
D2-10,14-17,23-33,35-41,48,49-52,54-63,67,69-77,83-85,87,100-104,110,111,20,80,81,403,12,R295	EDSS00355Y	DIODE 1SS355
D89,90,109,94	ED1N04148Y	DIODE 1N4148
D78,79,86,88,Q401	EDSS00184Y	DIODE 1SS184
D21,42,44,45,46,47	ED1V00217Y	DIODE 1SV217
D22,107,95,96,97,108	ED1V00231Y	DIODE 1SV231

D34	EDHM0198SY	DIODE HSM198S
D18,19,113,114	EDRS00135Y	DIODE RLS135
D65,98	EDMA0028TY	DIODE MA28T
D53,66	EDMA0028WY	DIODE MA28W
D105,106	EDRL04004X	DIODE RLR4004
D64	EDZD05519Y	ZENER DIODE 5.1V
D68	EDZD05759Y	ZENER DIODE 7.5V
D112	EDZD05569Y	ZENER DIODE 5.6V
VC2	CV038100AY	TRIMMER/C 10PF
L22	YCTLI2263C	CHOKE COIL 22μH
L15	YCTLI1053C	CHOKE COIL 1μH
L16	YCTLI2255C	CHOKE COIL 2.2μH
TP7-TP9	EPT120060A	PCB DC B+
R274,275	RCP121514Z	150Ω 1/2W
R270	RCP121034Z	10KΩ 1/2W
C217	CC0500501A	5PF 50WV
C214	CC0505604L	56PF 50WV
C222	CC0504704A	47PF 50WV
C209	CC0508204A	82PF 50WV
C215	CC0501215A	120PF 50WV
C216	CC0501815A	180PF 50WV
C221,223	CC0503915G	390PF 50WV
C220	CC1001037L	0.01μF 100WV
C219	CD3005614Z	560PF 300WV
C13,24,27,28,52,63,72,102,168,200,308,90	CE0251067Z	10μF 25WV
C188,198	CE0252267Z	22μF 25WV
C42,43,45,154,183,261	CE0254767Z	47μF 25WV
C166,260,103,128,329(C144)	CE0161077Z	100μF 16WV
C161,185,328	CE0163377Z	330μF 16WV
C269,270	CE0251087Z	1000μF 25WV
FL1	EFCFW455HT	CERAMIC FILTER CFW-455HT
FL2	EFCFE107MX	CERAMIC FILTER SPE10.7MX
FL3	EFX8106952	CRYSTAL FILTER 10.695MHz
X1	EYCAB10240	CRYSTAL 10.24MHz
X2	EYBAB10100	CRYSTAL 10.1MHz
X3	EYBAE10697	CRYSTAL 10.6975MHz
IC5	ENMA00612Z	IC AN-612
IC7	ENTA07222A	IC TA7222AP
IC9	ENSM06130Z	IC TDA6130
IC9	ENRCI06130	MODULAR IC100
Q51	T2SA01869Z	TR 2SA1869
Q60,61	T2SC02312C	TR 2SC2312C
Q62	T2SC02166C	TR 2SC2166C
Q63	T2SC02538Z	TR 2SC2538
Q66	T2SB00754Y	TR 2SB754Y
D91,92,93	ED1N04148Z	DIODE 1N4148
L2,3	ECIFT12002	I.F.T
L20	ECIFT12013	I.F.T.
L18,19	ECIFT12016	I.F.T.
L1,11	ECIFT12252	I.F.T.
L5	ECIFT12253	I.F.T.
L38	ECIFT12255	I.F.T.
L9,10	ECIFT12256	I.F.T.
L12	ECIFT12257	I.F.T.
L34	ECIFT12559	I.F.T.
L35	ECIFT12560	I.F.T.
L13,14,17	ECIFT12264	I.F.T.
L37	ECIFT12265	I.F.T.
L6	ECIFT12290	I.F.T.
L7	ECIFT12440	I.F.T.
L8	ECIFT12492	I.F.T.
L4	ECIFT12526	I.F.T.
L27,28,31	ECCHK16070	CHOKE COIL 22μH
T1	ECCHK16004	CHOKE COIL 1.1mH
L24	ECSPG18003	SPRING COIL 0.8x6.5x7.5t

L23	ECSPG18075	SPRING COIL 0.8x6x8.5t
L25	ECSPG18077	SPRING COIL 0.8x6x6.5t
L29	ECSPG18090	SPRING COIL 0.8x3x4t
L26	ECSPG18365	SPRING COIL 0.8x6.5x7.5t
L33	ECBAD18526	BEAD COIL 3.5x6x1.2
L32	ECRFZ10048	RF COIL 25μH
VR8,9,13,17,19	RE10200041	S/F/R 1KΩ
VR14,15	RE50200042	S/F/R 5KΩ
VR1,2,7,16,18	RE10300031	S/F/R 10KΩ
VR10	RE10400043	S/F/R 100KΩ
VR3,4	RE50400087	S/F/R 500KΩ
VR11,12	RE10100074	S/F/R 100Ω
J4,11,12,19,20,16	EX07N48223	PCB CONN/S 2P
J2,18,28	EX07N48350	PCB CONN/S 3P
J10	EX07N41216	PCB CONN/S 3P
J25	EX07N48222	PCB CONN/S 5P
J3,16,23	EX07N48331	PCB CONN/S 6P
J27	EX07N48224	PCB CONN/S 7P
TP1,3,5,10,11,12,13,15,16,17	EX07N48612	PCB CONN/S 1P
TP7,8,9	XZZZ90006Z	PCB STOPPER
J14	WX01070703	JUMPER WIRE
L30,36	WX01070710	JUMPER WIRE
-	MT2950050X	SHIELD COVER A
-	MT2950060X	SHIELD COVER B
-	MT2950070X	SHIELD COVER C

RCI-2985DX MISC. PART

REFERENCE NUMBER	RANGER PART NO.	DESCRIPTION
-	MT0SSB305X	HEATSINK E
IC7	MM5500100X	HEATSINK C
IC7	LZZZ61008Z	IC SHIELD B
Q66	XZZZ90020Z	INSULATING PLATE
Q60,61,62	XZZZ90003Z	INSULATING RING
Q60,61,62	XZZZ90358Z	INSULATING PLATE
Q51	JS052006MN	SET SCREW
Q66	JS052010MN	SET SCREW
Q60,61,62	JS052012MN	SET SCREW
IC7	JS013008MV	SET SCREW
121Z	CC0502237L	0.022μF 50WV
-	CE0351097Z	10000μF 35WV
METER-METER	RCP202204Z	22Ω 2W
-	EDBGAA121Z	BRIDGE RECTIFIERS 10A
-	EX02N40214	FUSE 125V 5A
-	EX03N40473	RF/SWR METER
-	EX03N40493	SIGNAL METER
-	EX04N40620	MICROPHONE ASSY
-	EX06T41024	RCA SOCKET
-	EX06N41029	ANT JACK
-	ES300835SQ	SPEAKER
-	EWPS33050X	POWER SW
-	ETP8620129	T/F EI-86
-	TZ2N03771Z	TR 2N3771
-	WA0100180A	AC CORD 110V
METER	EX01N40080	LAMP 5.3V 40mA
J20-RCA JACK	EX07N48346	WIRE CONN/H 2P
180B(J181)-RCA JACK, 180B(J183)-MAIN PCB	EX07N48510	WIRE CONN/H 2P
41Z(CN610)-70Z(J102)	EX07N48513	WIRE CONN/H 3-3P
90A-41Z(CN604)	EX07N48514	WIRE CONN/H 3-3P
180B(J182)-SP	EX07N48874	WIRE CONN/H 2P

41Z(SK2)-31Z, 41Z(SK1)-31Z	EX07N48518	WIRE CONN/H 6-6P
90Z(J402)-41Z(CN603)	EX07N48519	WIRE CONN/H 3-3P
180B(J184)-200B	EX07N48994	WIRE CONN/H 3P
J23-41Z(CN607)	EX07N49038	WIRE CONN/H 6-6P
J4-180B(J180)	EX07N49227	WIRE CONN/H 2-2P
J16-140B(J140)	EX07N49228	WIRE CONN/H 6-6P
J19-120B(J121)	EX07N49123	WIRE CONN/H 2-2P
J12-41Z(CN601)	EX07N49125	WIRE CONN/H 4-2P
J11-20Z	EX07N49128	WIRE CONN/H 2P
J10-41Z(CN605)- 70Z(J701)-70Z(J703)	EX07N49138	WIRE CONN/H 3-3-2-2P
J28-130B(J132)	EX07N49195	WIRE CONN/H 3-3P
J25-130B(J130)	EX07N49196	WIRE CONN/H 5-5P
J27-90Z(J401)	EX07N49197	WIRE CONN/H 7-7P
J3-41Z(CN606)	EX07N49198	WIRE CONN/H 6-6P
J2-180B(J185)	EX07N49199	WIRE CONN/H 3-3P
J18-METER-150B(J150)- METER-41Z(CN608)-J16	EX07N49200	WIRE CONN/H 5-3-2-2P
DIODE-E/C,62A(GND)- E/C	WH0213005Z	LEAD WIRE RED
DIODE-E/C,62A(C+)-E/C	WH0913005Z	LEAD WIRE WHITE
62A(SW1)-POWER SW	WH0222005Z	LEAD WIRE RED
62A(SW2)-POWER SW	WH0320005Z	LEAD WIRE ORANGE
62A(TR604/C)-2N5301	WH0225005Z	LEAD WIRE RED
62A(TR604/E)-2N5301	WH0425005Z	LEAD WIRE YELLOW
62A(TR604/B)-2N5301	WH0925005Z	LEAD WIRE WHITE
62A(GND)-MAIN PCB(GP)	WH0049005Z	LEAD WIRE BLACK
62A(B+)-MAIN PCB(V+)	WH0251005Z	LEAD WIRE RED
METER-METER	WL0010005Z	LEAD WIRE BLACK
CPU(LP1)-METER, CPU(LP2)-METER	WL0017005Z	LEAD WIRE BLACK
90B(FUSE LINE)- FUSE JACK	WJ0319005Z	LEAD WIRE ORANGE
ANT JACK- MAIN PCB(ANT)	WX03001012	COAXIAL CABLE
-	MTTURB180A	FRONT PANEL
-	PTTURB010A	RUBBER KEY PANEL
-	PTTURB020A	REFLECTOR PLATE
-	PTTURB030A	DISPLAY WINDOW
-	PT0SSB010A	GLASS WINDOW HOLDER
-	PT0SSB040A	PLASTIC FOOT
-	PT0SSB070A	METER BACK COVER
-	PT0SSB092A	ACRY WINDOW
-	PT3600090A	KNOB WASHER
-	PA0100010A	MICA INSULATOR
-	MT0SSB430X	SHIELD PLATE
-	MTTURB012X	FRONT CHASSIS
-	MTTURB110X	METER HOLDER
-	MTTURB140D	CHANNEL KNOB
-	MTTURB150A	PUSH BUTTON
-	MT0SSB170N	MIC BRACKET
-	MT0SSB101K	INDICATOR NAME PLATE
-	MT0SSB161B	VR KNOB BLACK
-	MT0SSB010B	TOP COVER BLACK
-	MT0SSB021S	BOTTOM PLATE
-	MT0SSB071S	RIGHT SIDE BRACKET
-	MT0SSB081S	LEFT SIDE BRACKET
-	MT0SSB120B	HANDLE ASSY BLACK
-	MT0SSB130B	HANDLE ASSY BLACK
-	MT0SSB141S	HANDLE BRACKET
-	MT0SSB310X	HEATSINK COVER
-	MT0SSB272A	BACK PANEL

-	MT0SSB296X	MAIN PCB CHASSIS
-	MT0SSB360X	PT SUPPORTER
PT	MT0SSB371X	PT FIXED PLATE
POWER INPUT PCB	MD0360041X	HEXANGULAR SCREW
-	MT0SSB252B	HEATSINK D
-	MT3600090T	D SPRING B
-	MT3600100T	D SPRING D
-	QT2950010A	RUBBER KEY
PA,EXT SP,CW KEY	QM5500030A	EARPHONE COVER
TOP COVER	LZZZ60018Z	SHIELD CLOTH A
SPEAKER	LZZZ60020Z	SHIELD CLOTH C
FEET	LZZZ60021Z	FOOT WASHER
METER	XZZZ90061Z	FOAM
BUZZER	XZZZ90206Z	SPONGE
-	XZZZ90091Z	FOAM
2N5301(1)	XZZZ90002Z	SOLDER PLATE
2N5301(2)	XZZZ90316Z	INSULATING RING
-	XZZZ90057Z	EAR PVC WASHER
MOD PCB,SWR PCB	XZZZ90004Z	FOAM
-	XZZZ90098Z	SOLDER PLATE
KEY PCB	XZZZ90367Z	SPONGE
CPU PCB	XZZZ90374Z	SPONGE
-	GZZZ50000Z	CLAMP
-	GZZZ50049Z	FUSE HOLDER
-	GZZZ50168Z	CORD BUSHING
-	BT6300041A	MIC PLATE
-	JW324008CN	IN-TOOTH WASHEH
-	JS114012MQ	SET SCREW
HANDLE	JS035012MB	SET SCREW
FRONT PLATE	JS033006MN	SET SCREW
HANDLE(4), TOP COVER(4)	JS055012MB	SET SCREW
PCB CHASSIS(4)	JS054008MS	SET SCREW
EARPHONE(2)	JS053008MB	SET SCREW
C605	JS053010MN	SET SCREW
2N5301(2)	JS053012MN	SET SCREW
-	JS013006SN	SET SCREW
HEATSINK(4)	JS053008SN	SET SCREW
-	JS053008TB	SET SCREW
HEATSINK(4)	JS053208WB	SET SCREW
ANT(3)	JS053008TH	SET SCREW
SPEAKER(4),PLATE(1)	JS053508TH	SET SCREW
FEET(4)	JS013014TH	SET SCREW
-	JS013008TH	SET SCREW
RECIFITER	JS033018MN	SET SCREW
2N5301(2)	JN243024ZS	NUT
PT	JN284007ZN	LOSK NUT
EAR PHONE	JW306011EY	WASHER
SET(TOP COVER)x4, HANDLE(4)	JW305312FB	WASHER
-	JW344006GN	SPRING WASHER
PCB(5)	JW323006DN	IN-TOOTH WASHER
-	JN263035ZS	NUT WITH WASHER
FEET	JW304009FS	WASHER
-	JW315510CN	OUT-TOOTH WASHER
-	JS015010WH	SET SCREW
-	EX02N40214	FUSE 125V 5A
-	XZZZ90008Z	MIC STOPPER

**PART LIST
RCI-2995DX MAIN PCB**

REFERENCE NUMBER	RANGER PART NO.	DESCRIPTION
	EPT695011A	MAIN P.C.B
R316,317,318,321,328,245,177	RCY010004Z	0Ω 0.1W
R277	RCY014794Z	4.7Ω 0.1W
R179,144	RCY011004Z	10Ω 0.1W
R293	RCY011504Z	15Ω 0.1W
R272,273	RCY012204Z	22Ω 0.1W
R246	RCY013304Z	33Ω 0.1W
R115,226,281	RCY014704Z	47Ω 0.1W
R227,231	RCY015604Z	56Ω 0.1W
R11,105	RCY016804Z	68Ω 0.1W
R3,5,8,32,36,78,97,145,172,143,182,186,286,289,154,158	RCY011014Z	100Ω 0.1W
R35,104,276,280,136,253	RCY011514Z	150Ω 0.1W
R23	RCY011814Z	180Ω 0.1W
R166,171,190,130,262	RCY012214Z	220Ω 0.1W
R33,103	RCY012714Z	270Ω 0.1W
R6,10,16,279,282,306	RCY013314Z	330Ω 0.1W
R148,170,202,250,259,304,24,404,116	RCY014714Z	470Ω 0.1W
R146,167,263,292	RCY015614Z	560Ω 0.1W
R4,50,90,224	RCY016814Z	680Ω 0.1W
R74	RCY018214Z	820Ω 0.1W
R19,22,64,67,71,75,82,101,117,122,127,149,150,152,174,178,192,199,207,213,225,233,244,255,257,258,266,267,268,269,271,294,297,307,308,322,326,134,329,96,D99	RCY011024Z	1KΩ 0.1W
R91,205	RCY011224Z	1.2KΩ 0.1W
R56,89,100,220,221,260,278,283,299,79,80	RCY011524Z	1.5KΩ 0.1W
R235	RCY011824Z	1.8KΩ 0.1W
R27,30,70,73,95,209,214,254,288,302,310,311,320,403	RCY012224Z	2.2KΩ 0.1W
R9,25,31	RCY012724Z	2.7KΩ 0.1W
R18,28,66,113,184,204,230,298,305	RCY013324Z	3.3KΩ 0.1W
R52,58	RCY013924Z	3.9KΩ 0.1W
R29,72,86,139,140,141,142,159,162,163,206,211,212,215,216,256,261,327,247	RCY014724Z	4.7KΩ 0.1W
R87,94,201,290,291	RCY015624Z	5.6KΩ 0.1W
R14,42,43,69,85	RCY016824Z	6.8KΩ 0.1W

R92,300	RCY018224Z	8.2KΩ 0.1W
R1,13,17,20,38,39,57,65,68,83,88,118-121,123,126,157,164,165,168,173,187,188,194,217,223,135,137,239,240-243,153,248,251,252,296,301,309,313,124,128,131,265,323,324,160,249	RCY011034Z	10KΩ 0.1W
R191,138	RCY011234Z	12KΩ 0.1W
R193	RCY011534Z	15KΩ 0.1W
R93,110,222,155,40,41	RCY012234Z	22KΩ 0.1W
R2,264,228	RCY013334Z	33KΩ 0.1W
R46	RCY013934Z	39KΩ 0.1W
R7,34,62,63,99,132,175,198,229,234,319,200	RCY014734Z	47KΩ 0.1W
R236	RCY015634Z	56KΩ 0.1W
R26,107,112,181	RCY016834Z	68KΩ 0.1W
R45	RCY018234Z	82KΩ 0.1W
R12,44,48,49,51,53,76,77,106,109,114,169,176,195,197,232,238,284,285,303,312,125	RCY011044Z	100KΩ 0.1W
R156	RCY011544Z	150KΩ 0.1W
R183	RCY011844Z	180KΩ 0.1W
R21,47,59,84,147,151,210,218,111	RCY012244Z	220KΩ 0.1W
R54,55,185,189	RCY012744Z	270KΩ 0.1W
R15,37,196,219	RCY014744Z	470KΩ 0.1W
R102	RCY018244Z	820KΩ 0.1W
R108,161,133	RCY011054Z	1MΩ 0.1W
R208	RCY011554Z	1.5MΩ 0.1W
C248	CK1059AB1A	0.5PF 50WV
C236,249,61	CK1010AB1A	1PF 50WV
C208,218	CK1030AB1A	3PF 50WV
C68,69,88,95,121,253,86,148,155,211	CK1050AB1A	5PF 50WV
C108	CK1080AB2A	8PF 50WV
C1,57,142,147	CK1100AB2A	10PF 50WV
C98,117	CK1150AB4A	15PF 50WV
C51	CK1180AB4A	18PF 50WV
C150,133	CK1220AB4A	22PF 50WV
C44,242	CK1270AB4A	27PF 50WV
C19,30,120,136,89	CK1330AB4A	33PF 50WV
L37(PIN4-6)	CK1330AA4A	33PF 50WV
C300,159,237,212	CK1470AB4A	47PF 50WV
C115,243	CK1680AB4A	68PF 50WV
C8	CK1820AB4A	82PF 50WV
C4,79,114,139,160,301,327	CK1101AB5A	100PF 50WV
C143	CK1121AB5A	120PF 50WV
C101	CK1151AB5A	150PF 50WV
C35,131	CK1221AB5A	220PF 50WV
C39	CK1271AB5A	270PF 50WV
C11,14	CK1331AB5A	330PF 50WV
C60,62	CK1471AB5A	470PF 50WV
C29,227	CK1561AB5A	560PF 50WV
C206	CK1390AB4D	39PF 50WV
C291	CK1100AB2G	10PF 50WV
C119	CK1330AB4G	33PF 50WV
C18,118,135	CK1680AB4G	68PF 50WV
C134	CK1101AB5G	100PF 50WV
C202,205	CK1151AB5G	150PF 50WV
C17,289	CK1271AB5G	270PF 50WV
C203	CK1331AB5G	330PF 50WV
C20,100	CK1391AB5G	390PF 50WV
C256	CK1103AB7A	0.01μF 50WV
C48,64,85,104,124,288,182,210,229,230,231,239,245,246,257,263,287,304,326,112,122,146,152,225,271,275,278,282,285,286,295,302,156,279,280,111,307,309,310,311,312,313,	CK2104AB7R	0.1μF 25WV

320		
C2,3,6,9,15,21,22,25,33,34,37,59,65-67,73,76,87,92,96,97,105,106,324,116,123,132,141,70,325,145,149,153,158,175,176,177,193,196,197,201,207,224,226,232,234,235,238,240,250,251,254,255,268,292,297-299,303,190,281,38,82,99,71,403	CK1103AB5X	0.01 μ F 50WV
C7,31,36,55,58,83,93,107,267,138,330,178,181,191,192,204,259,265,266	CK1102AB7L	0.001 μ F 50WV
C5,16,23,26,41,56,74,75,77,78,81,157,162,170,199,258,262,272,273,274,277,283,284,296,80	CK1473AB7R	0.047 μ F 50WV
C10	CK2474AB7R	0.47 μ F 25WV
C144	CK5475AA7R	4.7 μ F 16WV
C47,49,165,174,110,127	CK1223AB6U	0.022 μ F 50WV
C171	CK1153AB6U	0.015 μ F 50WV
C12	CK1222AB7R	0.0022 μ F 50WV
C40,50,53,54,172,173,241,184	CK1472AB6U	0.0047 μ F 50WV
C186	CK2224AB7R	0.22 μ F 25WV
C169,264,233	CK5225AA7R	2.2 μ F 16WV
C32,84,126,151,179,180,194,195,306,94	CK5105AB7R	1 μ F 16WV
C130,322	CTY161046Z	0.1 μ F 16WV
C163	CTY162246Z	0.22 μ F 16WV
C164,167,213,109,125,137,147	CTY161056Z	1 μ F 16WV
C129	CTY162256Z	2.2 μ F 16WV
C189,140,323,46	CTY164756Z	4.7 μ F 16WV
IC4	YNMA08005M	IC AN8005M-E2
IC1	YNJR00324M	IC NJM324M
IC6	YNJR04558M	IC NJM4558M
IC3	YNJR03404A	IC NJM3404M
IC2	YNMC45162D	IC MC145162D
IC9	YNSM6130X4	IC TDA6130
Q19,64	TY2SC3356Z	TR 2SC3356
Q47,49,67	TY2SB0798Z	TR 2SB798DL
Q3,5,6,8,15,18,30,35,40,43,44,45,48,50,53,55,57,65,68,69,71,28,401	TY2SC2712G	TR 2SC2712GR
Q7,41	TY2SA1298Y	TR 2SA1298Y
Q1,2,9,10,11,12,13,14,22,23,25,29,32,33,34,36,37,38,58,59,24	TY2SC2714Z	TR 2SC2714
Q73,74	TYTN2510N8	TR TN2510N8
Q16,17,26,27,52,54,56,70,72,76	TYZRN1403Z	TR RN1403
Q42,46	TYZRN2403Z	TR RN2403
Q20,21	FY2SK0302Z	F.E.T 2SK302
D1,11	EDSS00226Y	DIODE 1SS226
D82	EDSS00314Y	DIODE 1SS314
D2-10,14-17,23-33,35-41,48,49-52,54-63,67,69-77,83-85,87,100-104,110,111,20,80,81,403,12,R295	EDSS00355Y	DIODE 1SS355
D89,90,109,94	ED1N04148Y	DIODE 1N4148
D78,79,86,88	EDSS00184Y	DIODE 1SS184
D21,42,44,45,46,47	ED1V00217Y	DIODE 1SV217
D22,107,95,96,97,108	ED1V00231Y	DIODE 1SV231
D34	EDHM0198SY	DIODE HSM198S
D18,19,113,114	EDRS00135Y	DIODE RLS135
D65,98	EDMA0028TY	DIODE MA28T
D53,66	EDMA0028WY	DIODE MA28W
D105,106	EDRL04004X	DIODE RLR4004
D64	EDZD05519Y	ZENER DIODE 5.1V
D68	EDZD05759Y	ZENER DIODE 7.5V
D112	EDZD05569Y	ZENER DIODE 5.6V
VC2	CV038100AY	TRIMMER/C 10PF

L22	YCTLI2263C	CHOKE COIL 22 μ H
L15	YCTLI1053C	CHOKE COIL 1 μ H
L16	YCTLI2255C	CHOKE COIL 2.2 μ H
TP7-TP9	EPT120060A	PCB DC B+
R274,275	RCP121514Z	150 Ω 1/2W
R270	RCP121034Z	10K Ω 1/2W
C214	CC0501804L	18PF 50WV
C217	CC0503904A	39PF 50WV
C222	CC0504704A	47PF 50WV
C209	CC0508204A	82PF 50WV
C215	CC0501215A	120PF 50WV
C216	CC0501815A	180PF 50WV
C221,223	CC0503915G	390PF 50WV
C220	CC1001037L	0.01 μ F 100WV
C219	CD3005614Z	560PF 300WV
C13,24,27,28,52,63,72,102,168,200,308,90	CE0251067Z	10 μ F 25WV
C188,198	CE0252267Z	22 μ F 25WV
C42,43,45,154,183,261	CE0254767Z	47 μ F 25WV
C166,260,103,128,329(C144)	CE0161077Z	100 μ F 16WV
C161,185,328	CE0163377Z	330 μ F 16WV
C269,270	CE0251087Z	1000 μ F 25WV
FL1	EFCFW455HT	CERAMIC FILTER CFW-455HT
FL2	EFCFE107MX	CERAMIC FILTER SPE10.7MX
FL3	EFX8106952	CRYSTAL FILTER 10.695MHz
X1	EYCAB10240	CRYSTAL 10.24MHz
X2	EYBAB10100	CRYSTAL 10.1MHz
X3	EYBAE10697	CRYSTAL 10.6975MHz
IC5	ENMA00612Z	IC AN-612
IC7	ENTA07222A	IC TA7222AP
IC9	ENSM06130Z	IC TDA6130
IC9	ENRC106130	MODULAR IC100
Q51	T2SA01869Z	TR 2SA1869
Q60	T2SC02312C	TR 2SC2312C
Q62	T2SC02166C	TR 2SC2166C
Q66	T2SB00754Y	TR 2SB754Y
Q63	T2SC02538Z	TR 2SC2538
D91,92,93	ED1N04148Z	DIODE 1N4148
L2,3	ECIFT12002	I.F.T
L20	ECIFT12013	I.F.T.
L18,19	ECIFT12016	I.F.T.
L1,11	ECIFT12252	I.F.T.
L5	ECIFT12253	I.F.T.
L38	ECIFT12255	I.F.T.
L9,10	ECIFT12256	I.F.T.
L12	ECIFT12257	I.F.T.
L34	ECIFT12559	I.F.T.
L35	ECIFT12560	I.F.T.
L13,14,17	ECIFT12264	I.F.T.
L37	ECIFT12265	I.F.T.
L6	ECIFT12290	I.F.T.
L7	ECIFT12440	I.F.T.
L8	ECIFT12492	I.F.T.
L4	ECIFT12526	I.F.T.
L27,28,31	ECCHK16070	CHOKE COIL 22 μ H
T1	ECCHK16004	CHOKE COIL 1.1mH
L23,24	ECSPG18003	SPRING COIL 0.8x6.5x7.5t
L25	ECSPG18077	SPRING COIL 0.8x6x6.5t
L29	ECSPG18090	SPRING COIL 0.8x3x4t
L26	ECSPG18365	SPRING COIL 0.8x6.5x7.5t
L33	ECBAD18526	BEAD COIL 3.5x6x1.2
L32	ECRFZ10048	RF COIL 25 μ H

VR8,9,13,17,19	RE10200041	S/F/R 1K Ω
VR14,15	RE50200042	S/F/R 5K Ω
VR1,2,7,16,18	RE10300031	S/F/R 10K Ω
VR10	RE10400043	S/F/R 100K Ω
VR3,4	RE50400087	S/F/R 500K Ω
VR11,12	RE10100074	S/F/R 100 Ω
J10	EX07N41216	PCB CONN/S 3P
J25	EX07N48222	PCB CONN/S 5P
J4,11,12,19,20,22,5	EX07N48223	PCB CONN/S 2P
J27	EX07N48224	PCB CONN/S 7P
J3,16,23	EX07N48331	PCB CONN/S 6P
J2,18,28	EX07N48350	PCB CONN/S 3P
TP1,3,5,10,11,12,13,15,16,17	EX07N48612	PCB CONN/S 1P
TP7,8,9	XZZZ90006Z	PCB STOPPER
-	GZZZ50062Z	V TYPE JACK
J14	WX01070703	JUMPER WIRE
L30,36	WX01070710	JUMPER WIRE
-	MT2950050X	SHIELD COVER A
-	MT2950060X	SHIELD COVER B
-	MT2950070X	SHIELD COVER C

RCI-2995DX MISC. PART

REFERENCE NUMBER	RANGER PART NO.	DESCRIPTION
METER-METER	RCP202204Z	22 Ω 2W
41036	CC0501037L	0.01 μ F 50WV
EDBG2BD11Z	CC0502237L	0.022 μ F 50WV
-	EWPS33050X	POWER SW
-	EX02N40214	FUSE 125V 5A
-	ES300835SQ	SPEAKER
METER-METER	EX01N40080	LAMP 5.3V 40mA
-	EX03N40493	SIGNAL METER
-	EX03N40449	SWR/RF METER
-	ETPRC20099	R-CORE TRANSFORMER
-	EX06N41029	ANT JACK
-	EX06T41024	RCA SOCKET
-	EX06N41036	TERMINAL CONNECTOR
-	EX04N40620	MICROPHONE ASSY
J20-RCA JACK	EX07N48346	WIRE CONN/H 2P
MAIN PCB(J5)-RCA JACK	EX07N48888	WIRE CONN/H 2P
41Z(CN610)-70Z(J102)	EX07N48513	WIRE CONN/H 3-3P
90A-41Z(CN604)	EX07N48514	WIRE CONN/H 3-3P
180B(J182)-SP	EX07N48874	WIRE CONN/H 2P
41Z(SK2)-31Z, 41Z(SK1)-31Z	EX07N48518	WIRE CONN/H 6-6P
J22-POWER PCB(J1)	EX07N48999	WIRE CONN/H 2-2P
90Z(J402)-41Z(CN603)	EX07N48519	WIRE CONN/H 3-3P
180B(J184)-200B	EX07N48994	WIRE CONN/H 3P
J23-41Z(CN607)	EX07N49038	WIRE CONN/H 6-6P
J4-180B(J180)	EX07N49043	WIRE CONN/H 2-2P
J16-140B(J140)	EX07N49228	WIRE CONN/H 6-6P
J19-120B(J121)	EX07N49123	WIRE CONN/H 2-2P
J12-41Z(CN601)	EX07N49125	WIRE CONN/H 4-2P
J11-170B	EX07N49128	WIRE CONN/H 2P
J10-41Z(CN605)-70Z(J701)-70Z(J703)	EX07N49138	WIRE CONN/H 3-3-2-2P
J28-130B(J132)	EX07N49195	WIRE CONN/H 3-3P
J25-130B(J130)	EX07N49196	WIRE CONN/H 5-5P
J27-90Z(J401)	EX07N49197	WIRE CONN/H 7-7P
J3-41Z(CN606)	EX07N49198	WIRE CONN/H 6-6P
J2-180B(J185)	EX07N49199	WIRE CONN/H 3-3P
J18-METER-150B(J150)-METER-41Z(CN608)-POWER PCB(J2)	EX07N49229	WIRE CONN/H 5-3-2-2P
180B(J183)-MAIN PCB	EX07N48510	WIRE CONN/H 2P
METER-METER	WL0010005Z	LEAD WIRE BLACK

CPU(LP1)-METER, CPU(LP2)-METER	WL0017005Z	LEAD WIRE BLACK
E/C(-)-E/C(-)	WN0007027K	LEAD WIRE BLACK
E/C(+)-E/C(+)	WN0307027K	LEAD WIRE ORANGE
110B(B3)-E/C,110B(B4)-E/C	WI0020027R	LEAD WIRE BLACK
110B(B1)-E/C,110B(B2)-E/C	WI0320027R	LEAD WIRE ORANGE
190A(F)-50X/W,190A(G)-50X/W	WN0250011Q	LEAD WIRE RED
110B(B9)-50X/W	WI0360011S	LEAD WIRE ORANGE
E/C(-)	WN0060011B	LEAD WIRE BLACK
E/C(+)	WN0360011B	LEAD WIRE ORANGE
110B(B6)-MAIN(GP)	WI0060011S	LEAD WIRE BLACK
TC41036	WN0260005Z	LEAD WIRE RED
TC41036	WN0960005Z	LEAD WIRE WHITE
MAIN(V+)-50X/W	WN0373005Z	LEAD WIRE ORANGE
POWER PCB	WN0204005Z	LEAD WIRE RED
POWER PCB	WN0905505Z	LEAD WIRE WHITE
110B(B7)-POWER PCB (B-)--110B(B8)-POWER PCB(B+)00	WX07918170	LEAD WIRE RED/BLACK
190(A)-FUSE	WU0212011Q	TWIN S/WIRE RED
-	WA0100180A	AC CORD
POWER PCB(O/P)-ANT, POWER PCB(I/P)-MAIN(ANT)	WX04129230	RF CABLE
-	WX0040015B	PVC TUBE
-	WX0040009B	TUBE
-	CE0353397Z	33000 μ F 35WV
ANT JACK	GZZZ50062Z	V TYPE JACK
-	PTTURB010A	RUBBER KEY PANEL
-	PTTURB020A	REFLECTOR PLATE
-	PTTURB030A	DISPLAY WINDOW
-	PT0SSB010A	GLASS WINDOW HOLDER
-	PT0SSB040A	PLASTIC FOOT
-	PT0SSB070A	METER BACK COVER
-	PT0SSB092A	ACRY WINDOW
-	PT3600090A	KNOB WASHER
-	PA0100010A	MICA INSULATOR
-	MTTURB012X	FRONT CHASSIS
-	MTTURB180B	FRONT PANEL
-	MTTURB030A	BACK PANEL
-	MTTURB041X	MAIN PCB CHASSIS
-	MTTURB050K	HEATSINK COVER
-	MTTURB064B	REAR HEATSINK
-	MTTURB070X	PT HOLDER
-	MTTURB080X	PT BRACKET
-	MTTURB090X	POWER PCB HOUSING
-	MTTURB100X	TR HEATSINK
-	MTTURB110X	METER HOLDER
-	MTTURB140D	CHANNEL KNOB
-	MTTURB150A	PUSH BUTTON
-	MT0SSB021S	BOTTOM PLATE
-	MT0SSB071S	RIGHT SIDE BRACKET
-	MT0SSB081S	LEFT SIDE BRACKET
-	MT0SSB120B	HANDLE ASSY BLACK
-	MT0SSB130B	HANDLE ASSY BLACK
-	MT0SSB141S	HANDLE BRACKET
-	MT0SSB170N	MIC BRACKET
-	MT0SSB305X	HEATSINK E

-	MT0SSB010B	TOP COVER BLACK
-	MT0SSB390X	FIXED PLATE
-	MT0SSB101K	INDICATOR NAME PLATE
-	MT0SSB161B	VR KNOB BLACK
-	ML1645310X	ANT COVER
POWER PCB	MTTURB160X	ONSERT
-	MM5500100X	HEATSINK C
METER	BT6300041A	MIC PLATE
-	QT2950010A	RUBBER KEY
-	QM5500030A	EARPHONE COVER
CPU PCB	XZZZ90374Z	SPONGE
-	XZZZ90208Z	SPONGE
295031Z	XZZZ90367Z	SPONGE
-	GZZZ50000Z	CLAMP
-	GZZZ50168Z	CORD BUSHING
-	GZZZ50049Z	FUSE HOLDER
TOP COVER	LZZZ60018Z	SHIELD CLOTH A
SPEAKER	LZZZ60020Z	SHIELD CLOTH C
FEET	LZZZ60021Z	FOOT WASHER
2166,2312,473x1	XZZZ90003Z	INSULATING RING
-	XZZZ90358Z	INSULATING PLATE
-	XZZZ90057Z	EAR PVC WASHER
-	XZZZ90098Z	SOLDER PLATE
-	XZZZ90020Z	INSULATING PLATE
METER	XZZZ90061Z	FOAM
90Z PCB	XZZZ90357Z	U TYPE BRACKET
IC7808	XZZZ90072Z	INSULATING RING
BUZZER	XZZZ90206Z	SPONGE
-	XZZZ90091Z	FOAM
-	JS013006MN	SET SCREW
PT	JS055010MN	SET SCREW
HANDLE(4)	JS035012MB	SET SCREW
FRONT PLATE(3)	JS033006MN	SET SCREW
-	JS053208WB	SET SCREW
HANDLE(4), TOP COVER(4)	JS055012MB	SET SCREW
REA(2),PT BKT(4)	JS053008MB	SET SCREW
754(1),ANT(1)	JS053010MN	SET SCREW
IC(3)	JS052010MN	SET SCREW

2SA1869(1)	JS052006MN	SET SCREW
BACK PANEL(3), INDICATOR,PLATE(4)	JS053008TB	SET SCREW
-	JS053508TH	SET SCREW
FEET(4)	JS013014TH	SET SCREW
E I/C(4),PCB CHASSIS(2), HANDLE BKT(8),RIGHT/ LEFT(8),MAIN PCB(4), FRONT PANEL(2), POWER HOLDER(4), BOTTOM PLATE(8), MIC BKT(1),LED PCB(1), LCD HOLDER(4)	JS013008TH	SET SCREW
EPT0SSB110A	JS013508TH	SET SCREW
PT(4),PCB CHASSIS(4), PT	JS054008MS	SET SCREW
HEATSINK(4)	JS054018MB	SET SCREW
IC TA7222(1)	JS013008MV	SET SCREW
-	JS013006SN	SET SCREW
EAR PHONE(3)	JW306011EY	WASHER
SET/TOP COVER(4), HANDLE(4)	JW305312FB	WASHER
FEET(4)	JW304009FS	WASHER
POWER PCB(4),ANT(1)	JN243024ZS	NUT
-	JN263035ZS	NUT WITH WASHER
-	JE412004ZX	EYELET
-	JW315510CN	OUT-TOOTH WASHER
-	JS015010WH	SET SCREW
-	EX02N40214	FUSE 125V 5A
-	XZZZ90008Z	MIC STOPPER
-	EDBG2BC11Z	(22BC11) BRIDGE RECTIFIERS
-	EDBG2BD11Z	(22BD11) BRIDGE RECTIFIERS
(7222A)	LZZZ61008Z	IC SHIELD B

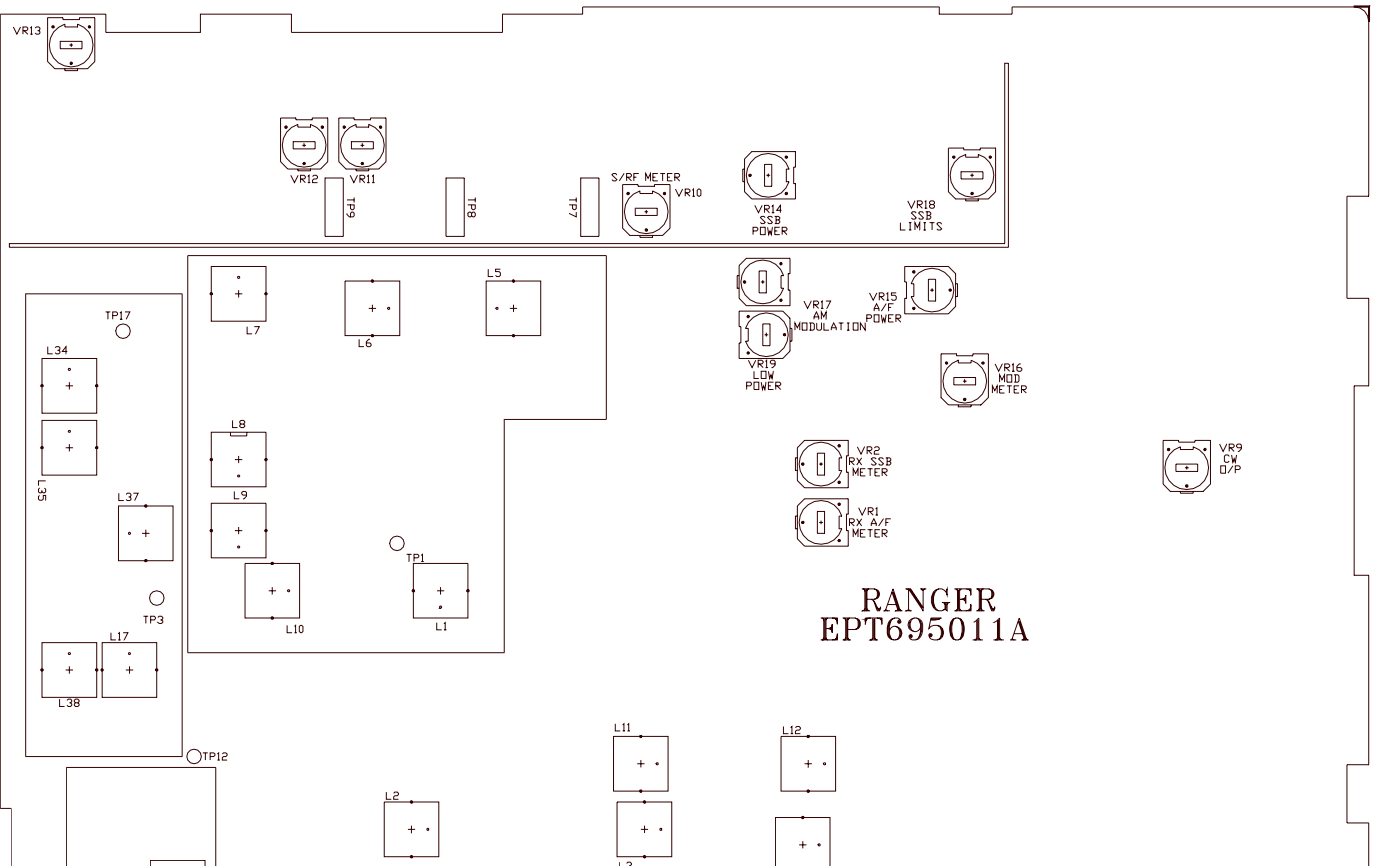

Main PCB Adjustment Location