

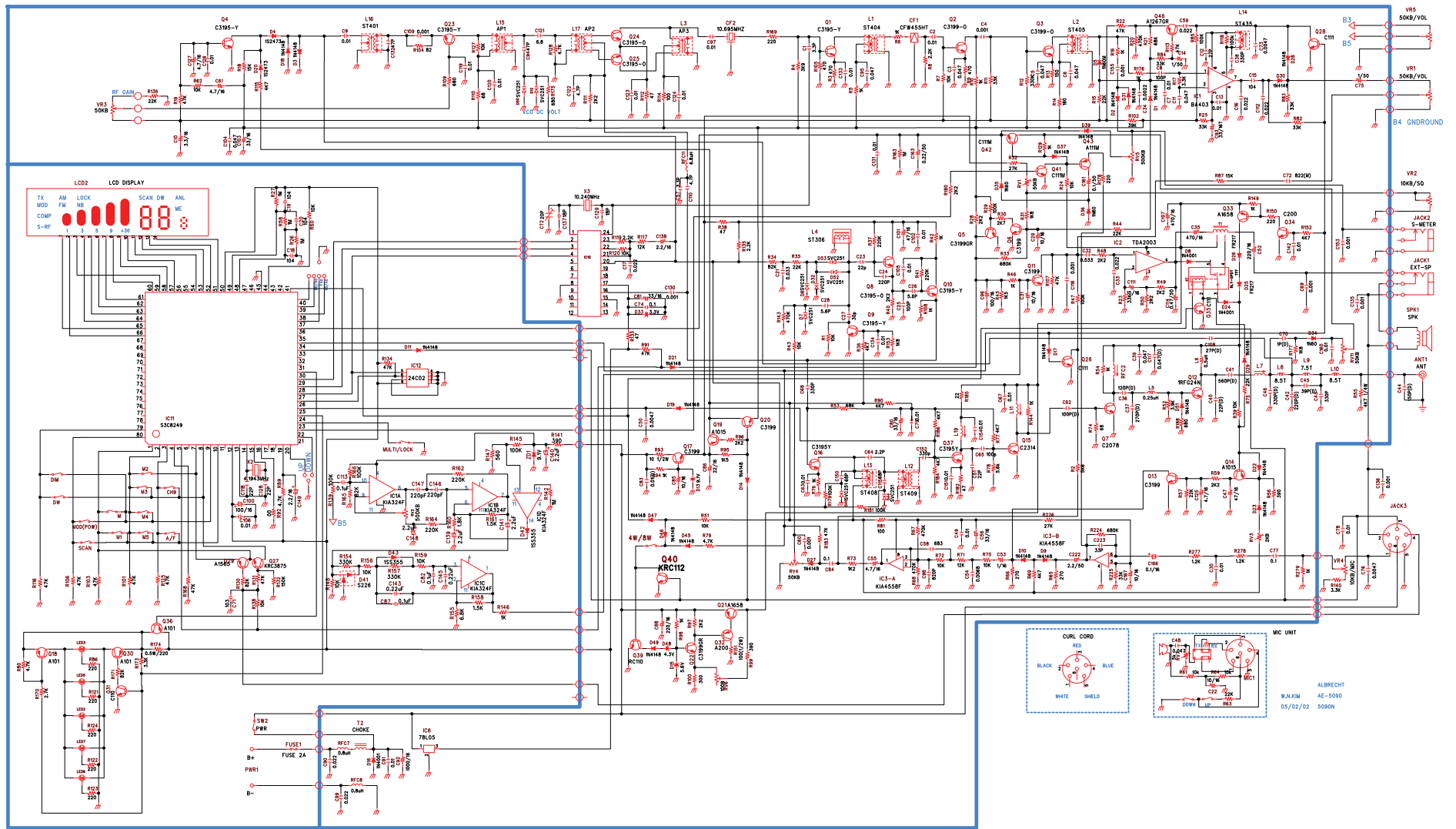

AE 5090 XL

SCHEMATIC DIAGRAM

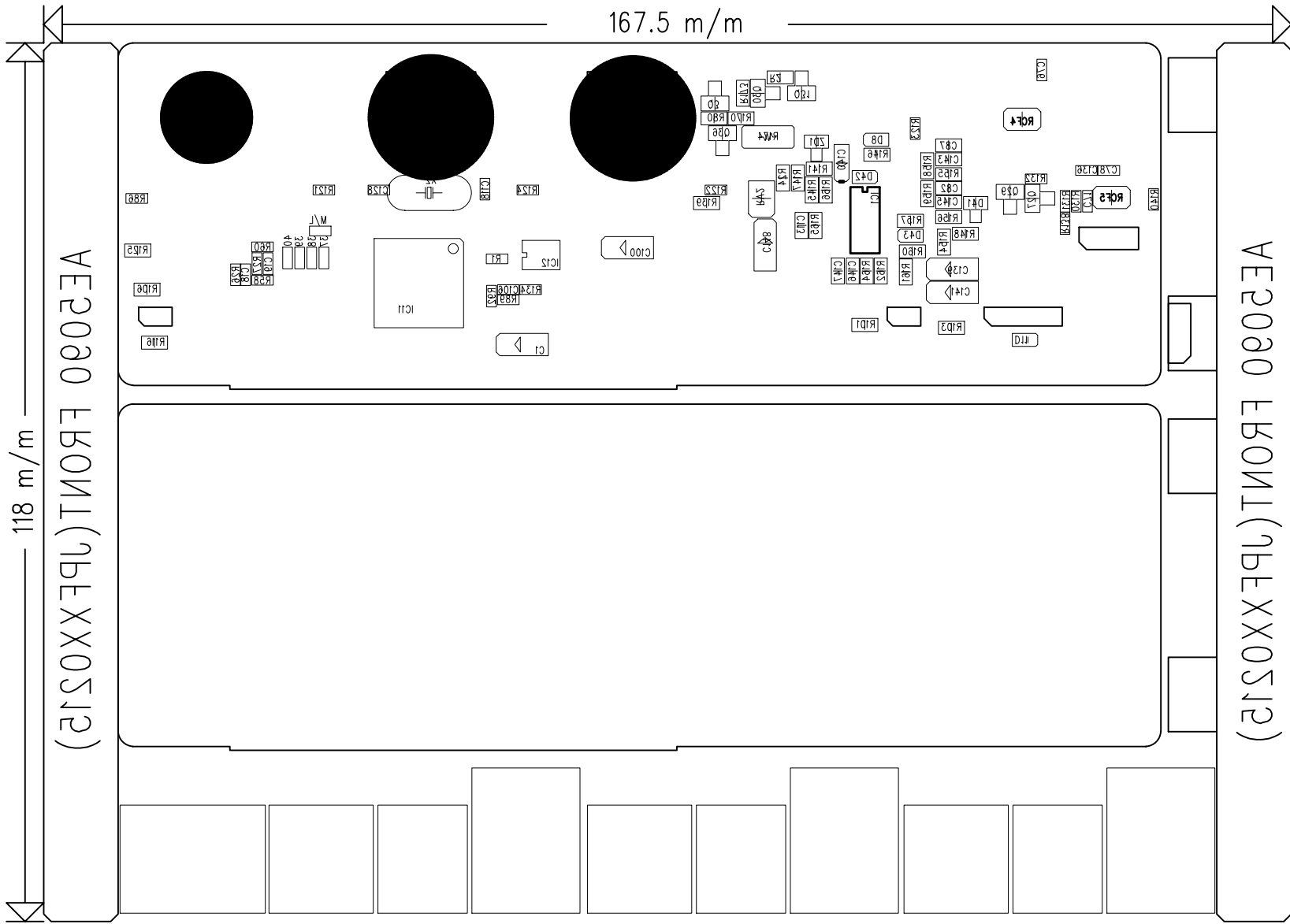



| | | | |
|----------|----------------------|-------------|----------------|
| | | SOLDER SIDE | |
| | | SEUNG YONG | |
| MODEL | AE 5090 | SCALE | 1=1 |
| BUYER | ALBRECHT | MAT'L | FR-4(1/1) |
| NAME | FRONT PCB SUB PCB | SIZE | 167.5X118X1.6T |
| DRAWN | CHECKED | APPROVED | PART NO |
| M.H.JUNG | | | JPFXX0215 |
| 01/08/28 | | | |

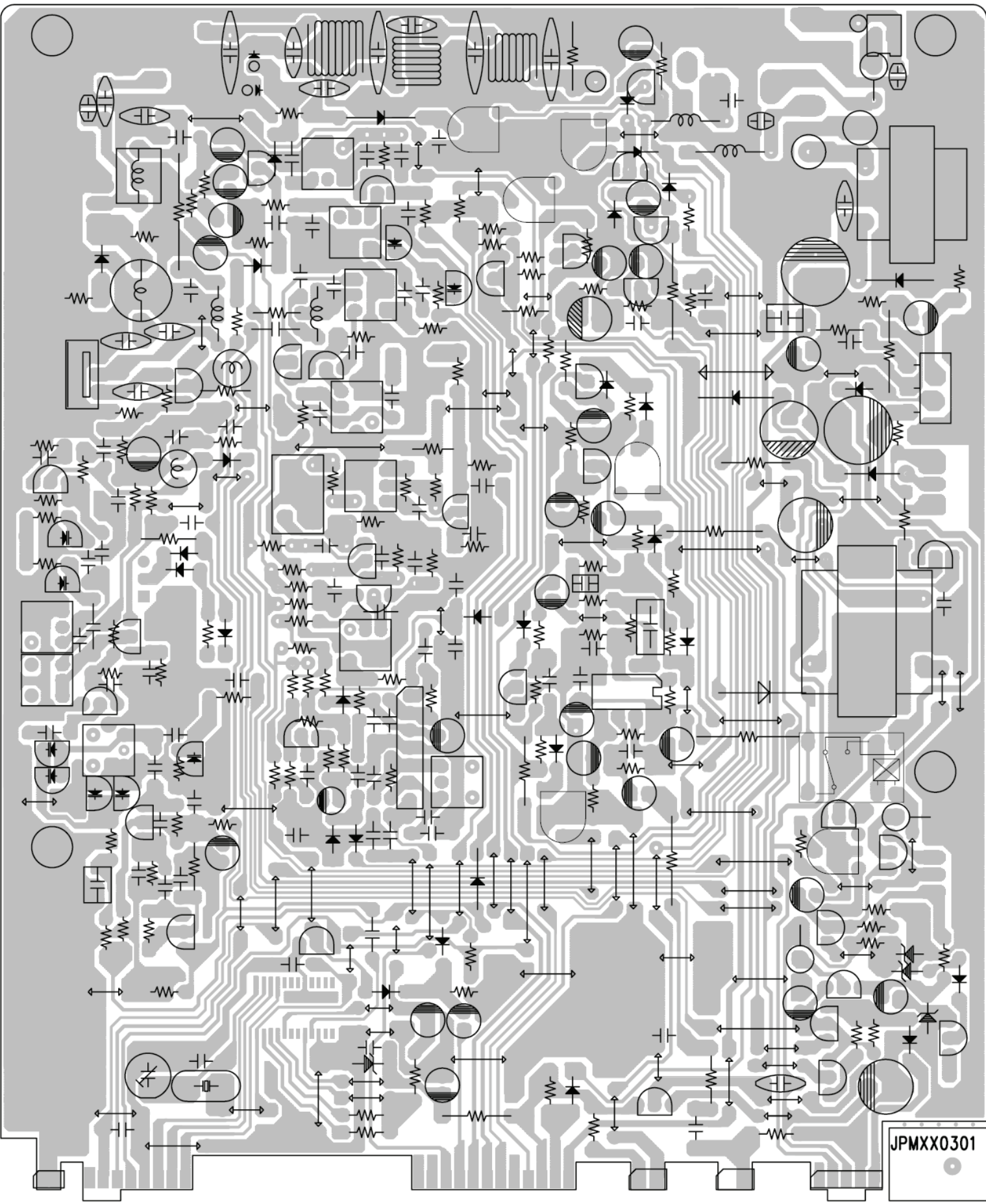

JPMXX0301

1 m/m

1 m/m

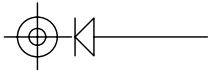

144 m/m

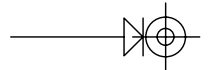

174.6 m/m

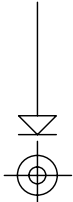
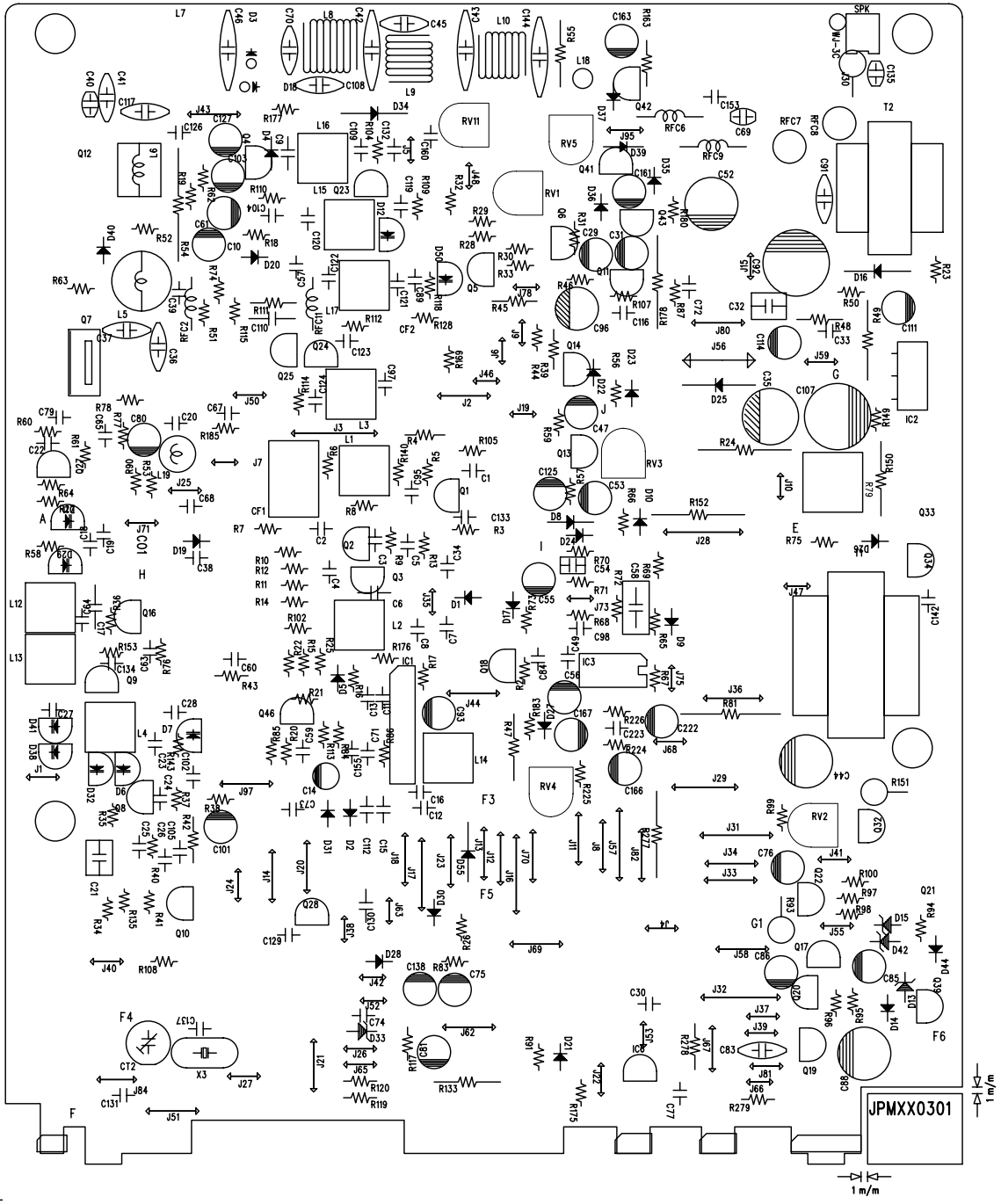

JPMXX0301
1 m/m

| | | | | | |
|----------------|----------|------------|---------------|------------------|--|
| | | | | COMP. SIDE | |
| | | | | SEUNG YONG | |
| SAMPL DELIVERY | MODEL | AE 5090 | SCALE | 1=1 | |
| BUYER | ALBRECHT | MAT'L | XPC-94HB(1/1) | | |
| SAMPLE Q'TY | NAME | MAIN P.C.B | SIZE | 174.625x144x1.61 | |
| DRAWN | CHECKED | APPROVED | PART NO | | |
| M.H.JUNG | | | | | |
| 01/03/16 | | | | | |

